

**PROTER**<sup>®</sup>

**2025**

 **Hirdavatsan**  
Teknik Hirdavat

**PROTER**<sup>®</sup>



# Yüksek Performans

# **Ekonomik**

## Hızlı Servis

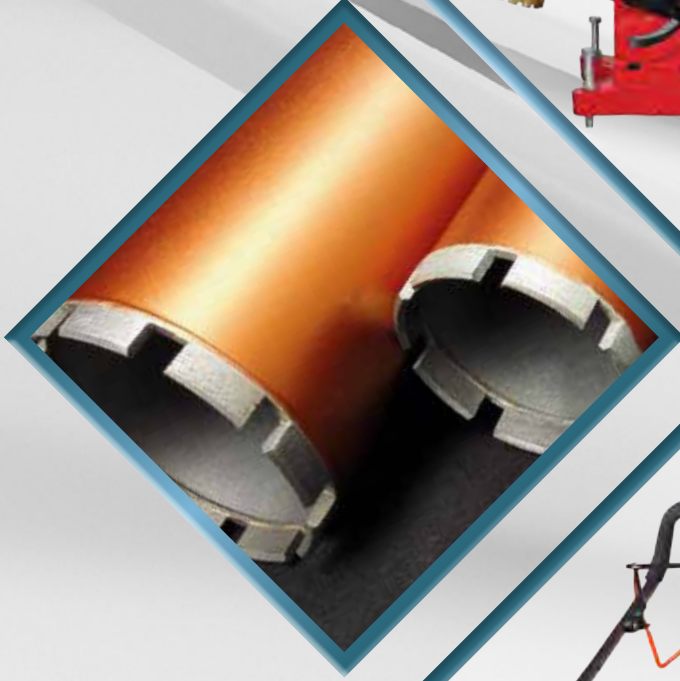

# Üstün Kalite

Ergonomik  
Tasarım

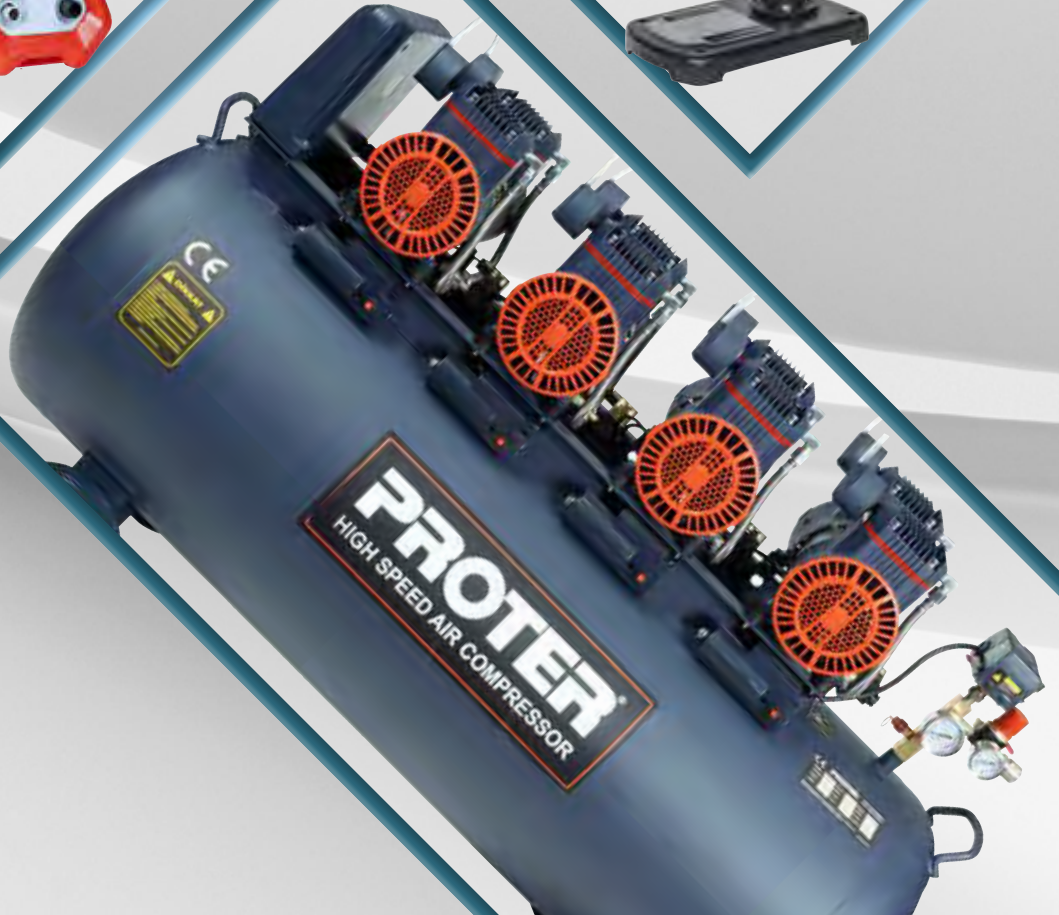

# FIHRIST

PROTER

Sessiz & Yağsız  
Hava Kompresörleri  
8-11



Yağlı Hava  
Kompresörleri  
12



Sessiz & Yağsız  
Hava Kompresörleri  
10-11



Yağsız-Hızlı  
Hava Kompresörleri  
13-15



Tezgahtip  
Pafta Makinaları  
18-23



Tezgahtip  
Yiv Açma Makinaları  
21-23



El Tipi Elektrikli  
Pafta Makinaları  
24



Hidrolik Boru Bükme  
Makinaları  
25



Inverter Kaynak  
Makinası  
108



Elmas Karot  
Uçları  
29



Karot  
Makinaları  
26-27



Karot  
Makinaları  
27-28



El Tipi  
Karot Matkapları  
30



Argon Tig Colormatic  
Kaynak Maskesi  
108



Şarjlı Vidalama Kit  
34



Şarjlı  
Alçıpan Vidalama  
34



Şarjlı Vidalama  
52 Parça Set  
35



Şarjlı Matkap  
35



Şarjlı Vidalama  
Tornavida  
36



Darbeli Şarjlı  
Vidalama  
36



Darbeli  
Şarjlı Matkap  
37



Şarjlı  
Matkaplar  
39



Kömürsüz Darbeli  
Şarjlı Matkaplar  
41



Kömürsüz Darbeli  
Şarjlı Matkaplar  
42



Kömürsüz Darbeli  
Şarjlı Tornavida  
40



Kömürsüz Darbeli  
Şarjlı Somun Sökme  
40



Şarjlı  
3'lü Setler  
46



Şarjlı  
4'lü Setler  
47



Kömürsüz Şarjlı Avuç  
Taşlama Makinaları  
43



# FIHRİST

PROTER

Kömürsüz Şarjlı Pnömatik  
Kırcı & Delici Matkaplar  
44



Kömürsüz Şarjlı Pnömatik  
Kırcı & Delici Matkaplar  
45



Şarjlı Dekupaj  
Makinası  
38



Kömürsüz Şarjlı  
Sunta Kesme  
38



Şarjlı Zincirli  
Budama Testereleri  
48



Şarjlı Zincirli  
Dal Kesme Makinaları  
49



Şarjlı Budama  
Makasları  
50-51



Kömürsüz Şarjlı Çit  
Budama Makinesi  
51



Vantuzlu Titreşimli  
Fayans Tokmak  
53



Şarjlı  
Silikon Tabancası  
53



Şarjlı  
Üfleyci  
52



Şarjlı  
Sıcak Hava Tabancası  
52



Şarjlı  
Lastik Şişirme  
54



Şarjlı  
Oto Yıkama  
54



Şarjlı & Pili  
Lazer Metreler  
58-59



Şarjlı Lazer Şakül  
Distomatlar  
61



Şarjlı Lazer  
Şaküller  
60-61



Çelik  
Şerit Metreler  
59



Şarjlı  
El Fenerleri  
116



Avuç Taşlama  
Makinaları  
65



Jet Taşlama  
Makinaları  
66-67



Polisaj  
Makinası  
69



Eksantrik / Orbital  
Polisaj Makinası  
69



Oto Polisaj & Döşeme  
Temizleme Makinası  
69



Kalıpcı Taşlama  
Makinaları  
68



Mini Grinder Mikro  
Kalıpcı Taşlama Seti  
68



Darbesiz  
Matkaplar  
70



Darbeli  
Matkaplar  
71



Pnömatik Kırcı  
Delici Matkaplar  
74



Karıştırıcı  
Matkaplar  
72



Elektrikli  
Somun Sökmeler  
73



Max Kırıcı & Delici  
Matkaplar  
75-76



Kırıcı  
Matkaplar  
77



Koyun Kırma  
Makinası  
80



Elektrikli Çok Amaçlı  
Multi Makina  
80



Sıcak Hava  
Tabancaları  
81



Tilki Kuyruğu  
Testere Makinaları  
82



Sunta Kesme  
Makinaları  
83



Formika & Laminant  
Temizleme Makinası  
84



El Freze  
Makinaları  
84



El Planya  
Makinası  
85



Dekupaj  
Makinaları  
85



Titreşim  
Zımpara Makinası  
86



Eksantrik & Orbital  
Zımpara Makinaları  
86



Zımpara  
Taş Motorları  
87



Havalı Döşeme & Çivi  
Tabancaları  
88-89



Duvar-Alçıpan  
Zımpara Makinası  
92



Kanal Açma  
Makinası  
92



Kanal Kazıma  
Makinaları  
93



Beton Vibratörleri &  
Hortumları  
94-95



Gönye Kesme  
Makinaları  
96-97



Radial Gönye Kesme  
Makinası  
97



Taşlı Metal Kesme  
Makinaları  
98



Sehpalı Tezgah  
Testere Makinası  
99



Elektrikli  
Zincirli Ağaç Kesme  
105



Benzinli Zincirli  
Ağaç Kesim Motorları  
105



Benzinli Misinalı  
Yan & Sırt Tırpanlar  
106



Benzinli Çim Bıçma  
Makinası  
107



Elektrikli Çim Bıçma  
Makinası  
107



Sütunlu Matkaplar  
99-101



Zincirli Ceraskallar & Hubzугlar  
110



Elektrikli Mini Vinçler  
111



Basınçlı Oto Yıkama Makinaları  
112



Lastik Şişirme Kompresörleri  
117



Düşük Profil Arabalı Krikolar  
113



Dik Şanzıman Krikosu  
113



Hidrolik Katlanır Vinçler  
114



Hidrolik Oto Doğrultmalar  
115



5'li Kompresör Seti  
118



Fasarit Boya Tabancası  
118



Boya Tabancaları  
120-121



Lastik Şişirme Tabancaları  
119



Mazot Tabancası  
118



Hava Tabancaları  
119



Tilki Kuyruğu Testereler  
126

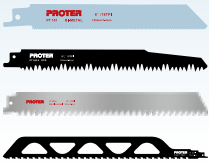

Elmas Paslanmaz Çelik Delme Pançlar  
127

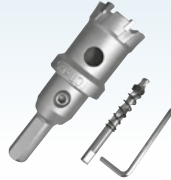

Kademeli Sac Delmeler  
128-129



Elmas Duvar Delme Buat Uçlar  
130



Supra & Anahtarlı Mandrenler  
131



Elmas Beton Delme Pançlar  
128



Elmas Granit & Mermer Delme Pançlar  
129



Bits Uçlar & Somun Adaptörleri  
130



Plus & Max Delici & Kırıcı Uçlar  
132-133

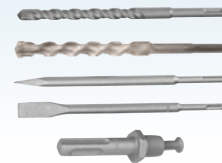

Hidrolik Su Test Pompası  
124



Pvc Boru Kesme Makasları  
124



Elmas Beton Testereler  
125

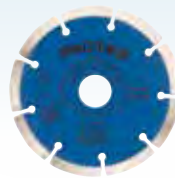

İnce Kesim Elmas Granit Testereler  
125



Çift Yüzeysel Elmas Testereler  
125



Süper Kesim Elmas Granit Testereler  
125

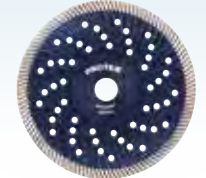

## FİHRİST

### HAVALI EL ALETLERİ

# AIR TOOLS HAVALI EL ALETLERİ

Havalı Orbital  
Döner Zımpara  
137



Havalı  
Somun Sökmeler 1/2"  
136-137



Havalı  
Somun Sökmeler 1/2"  
136-137



Havalı  
Somun Sökmeler 1/2"  
136-137



Havalı  
Somun Sökme / Çantalı Kit  
137



Havalı  
Somun Sökmeler 1"  
138



Havalı  
Somun Sökmeler 1"  
138



Havalı  
Sağ-Sol Matkaplar  
139



Havalı  
Keski Kırıcı / Çantalı Kit  
139



Hidrolik Pop Perçin  
Tabancası / Çantalı Kit  
139



Havalı  
Gres Pompası  
140



Havalı  
Cırcır Kol  
140



Havalı  
Cırcır Kol / Çantalı Kit  
140



Havalı  
Mikro Kalıpcı / Çantalı Kit  
141



Havalı  
Kalıpcı Taşlama  
141



Havalı  
Kalıpcı Taşlama / Çantalı Kit  
141



# Üstün Kalite

Ergonomik

Tasarım



190 \$

**PR 9 S**

**9 LT**  
**SESSİZ & YAĞSIZ**  
**HAVA KOMPRESÖRÜ**

Depo Hacmi	9 Lt
Güç / Watt	550 W
Basınç / Atü	8.0 Bar
Hava Debisi	102 Lt / dk
Voltaj	230 V~50 Hz
Ağırlık	15 Kg



**Sessiz** **Yağsız**

250 \$

**PR 24 S**

**24 LT**  
**SESSİZ & YAĞSIZ**  
**HAVA KOMPRESÖRÜ**

Depo Hacmi	24 Lt
Güç / Watt	750 W
Basınç / Atü	8.0 Bar
Hava Debisi	135 Lt / dk
Voltaj	230 V~50 Hz
Ağırlık	20 Kg



**Sessiz** **Yağsız**

360 \$



**PR 52 S**

**50 LT**  
**SESSİZ & YAĞSIZ**  
**HAVA KOMPRESÖRÜ**

Depo Hacmi	50 Lt
Watt	1100 W
Basınç / Atü	8.0 Bar
Hava Debisi	200 Lt / dk
Voltaj	230 V~50 Hz
Ağırlık	36 Kg



275 \$



**PR 50 S**

**50 LT**  
**SESSİZ & YAĞSIZ**  
**HAVA KOMPRESÖRÜ**

Depo Hacmi	50 Lt
Watt	750 W
Basınç / Atü	8.0 Bar
Hava Debisi	135 Lt / dk
Voltaj	230 V~50 Hz
Ağırlık	34 Kg



850 \$

## PR 103 S

### 100 LT - 3 HP SESSİZ & YAĞSIZ HAVA KOMPRESÖRÜ

Depo Hacmi	100 Lt
Watt	2250 W (3x750)
Güç (Hp)	3 HP
Basınç / Atü	8.0 Bar
Hava Debisi	405 Lt / dk
Voltaj	230 V~50 Hz
Ağırlık	66 Kg

-  3 HP
-  3 Kafa
-  Sessiz
-  Yağsız

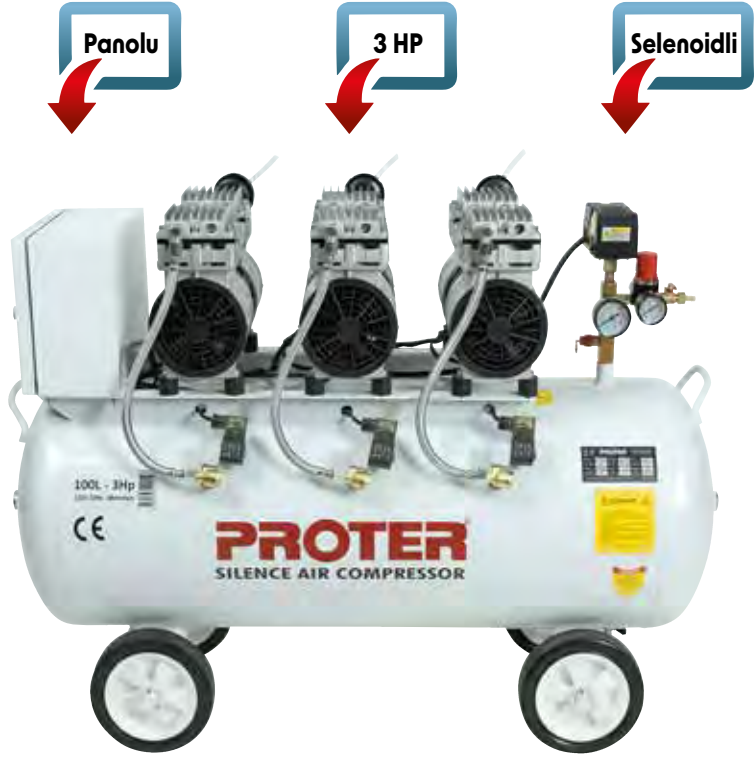

990 \$

## PR 203 S

### 200 LT - 3 HP SESSİZ & YAĞSIZ HAVA KOMPRESÖRÜ

Depo Hacmi	200 Lt
Güç (Hp)	3 HP
Watt	2250 W (3x750)
Basınç / Atü	8.0 Bar
Hava Debisi	405 Lt / dk
Voltaj	230 V~50 Hz
Ağırlık	100 Kg

-  3 HP
-  3 Kafa / Monofaze
-  Sessiz
-  Yağsız





1200 \$

## PR 204 S

### 200 LT - 4 HP SESSİZ & YAĞSIZ HAVA KOMPRESÖRÜ

Depo Hacmi	200 Lt
Güç (Hp)	4 HP
Watt	3000 W (4x750)
Basınç / Atü	8.0 Bar
Hava Debisi	540 Lt / dk
Voltaj	230 V~50 Hz
Ağırlık	108 Kg

-  4 HP
-  4 Kafa / Monofaze
-  Sessiz
-  Yağsız



1650 \$

## PR 226 S

### 220 LT - 6 HP SESSİZ & YAĞSIZ HAVA KOMPRESÖRÜ

Depo Hacmi	220 Lt
Güç (Hp)	6 HP
Watt	4500 W (4x1100)
Basınç / Atü	8.0 Bar
Hava Debisi	800 Lt / dk
Voltaj	230 V~50 Hz
Ağırlık	126 Kg

-  6 HP
-  4 Kafa / Monofaze
-  Sessiz
-  Yağsız

195 \$

## PR 52 YL

### 50 LT - 2 HP YAĞLI HAVA KOMPRESÖRÜ

Depo Hacmi	50 Lt
Güç (Hp)	2.0 HP
Basınç / Atü	8.0 Bar
Hava Debisi	198 Lt / dk
Voltaj	230 V~50 Hz
Ağırlık	32 Kg



- 2.0 HP
- Yağlı
- Sigortalı

650 \$

## PR 103 YL

### 100 LT - 3 HP YAĞLI HAVA KOMPRESÖRÜ

Depo Hacmi	100 Lt
Güç (Hp)	3.0 HP - 2 Kafa
Basınç / Atü	8.0 Bar
Hava Debisi	250 Lt / dk
Voltaj	230 V~50 Hz
Ağırlık	78 Kg



- 3 HP
- Çift Kafa
- Kayışlı
- Kasnaklı

850 \$

## PR 203 YL

### 200 LT - 3 HP YAĞLI HAVA KOMPRESÖRÜ

Depo Hacmi	200 Lt
Güç (Hp)	3.0 HP - 2 Kafa
Basınç / Atü	8.0 Bar
Hava Debisi	250 Lt / dk
Voltaj	230 V~50 Hz
Ağırlık	98 Kg



- 3 HP
- Çift Kafa
- Monofaze
- Kayışlı
- Kasnaklı

285 \$



## PR 52 HZ

### 50 LT - 2 HP HIZLI & YAĞSIZ HAVA KOMPRESÖRÜ

Depo Hacmi	50 Lt
Güç (Hp)	2 Hp
Basınç / Atü	8.0 Bar
Hava Debisi	245 Lt / dk
Voltaj	230 V~50 Hz
Ağırlık	26 Kg

 Hızlı Dolum

 Yağsız

 Düşük Ses Seviyesi

485 \$



## PR 54 HZ

### 50 LT - 4 HP HIZLI & YAĞSIZ HAVA KOMPRESÖRÜ

Depo Hacmi	50 Lt
Güç (Hp)	4 Hp
Basınç / Atü	8.0 Bar
Hava Debisi	245 Lt / dk
Voltaj	230 V~50 Hz
Ağırlık	36 Kg

 Hızlı Dolum

 Yağsız

 Düşük Ses Seviyesi

700 \$

## PR 104 HZ

### 100 LT - 4 HP HIZLI & YAĞSIZ HAVA KOMPRESÖRÜ

Depo Hacmi	100 Lt
Güç (Hp)	4 HP
Basınç / Atü	8.0 Bar
Hava Debisi	490 Lt / dk
Voltaj	230 V~50 Hz
Ağırlık	56 Kg

 4 HP

 Düşük Ses

 Hızlı

 Yağsız

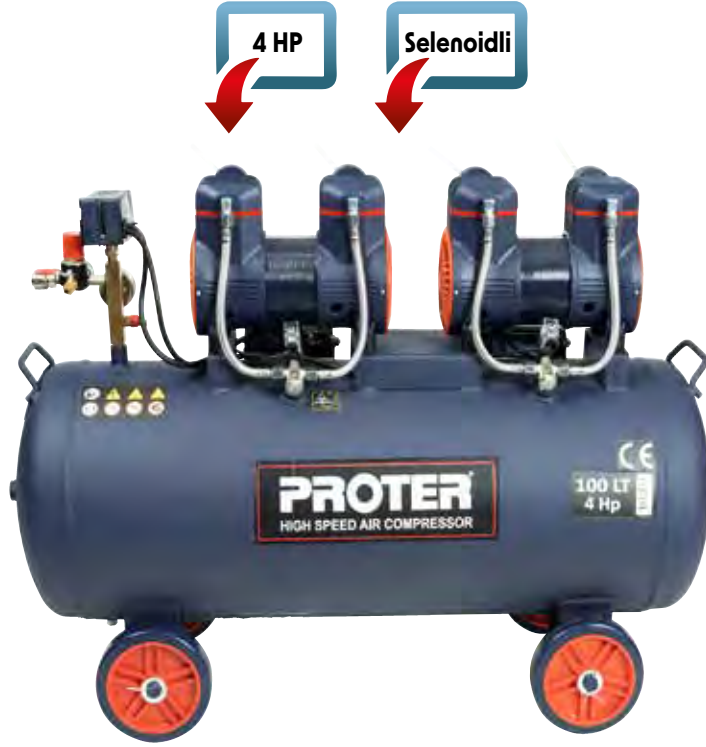

950 \$

## PR 106 HZ

### 100 LT - 6 HP HIZLI & YAĞSIZ HAVA KOMPRESÖRÜ

Depo Hacmi	100 Lt
Güç (Hp)	6 HP
Basınç / Atü	8.0 Bar
Hava Debisi	735 Lt / dk
Voltaj	230 V~50 Hz
Ağırlık	72 Kg

 6 HP

 Düşük Ses

 Hızlı

 Yağsız



1200 \$



## PR 206 HZ

### 200 LT - 6 HP HIZLI & YAĞSIZ HAVA KOMPRESÖRÜ

Depo Hacmi	200 Lt
Güç (Hp)	6 HP
Basınç / Atü	8.0 Bar
Hava Debisi	735 Lt / dk
Voltaj	230 V~50 Hz
Ağırlık	103 Kg



1400 \$



## PR 228 HZ

### 220 LT - 8 HP HIZLI & YAĞSIZ HAVA KOMPRESÖRÜ

Depo Hacmi	220 Lt
Güç (Hp)	8 HP
Basınç / Atü	8.0 Bar
Hava Debisi	980 Lt / dk
Voltaj	230 V~50 Hz
Ağırlık	122 Kg



Yüksek Performans  
**Ekonomik**  
Hızlı Servis



# Üstün Kalite

Ergonomik

Tasarım



920 \$

## PR 1002

### 2" TEZGAH TİP PAFTA MAKİNASI

Ölçü	1/2" - 2"
Watt	900 W
Devir Sayısı	1 Devir
Devir Hızı	28 d/dk
Voltaj	230 V~50 Hz
Ağırlık	62 Kg



- 2 inch
- 900 Watt
- Otomatik
- TezgaH Tip

#### Aksesuarlı

- 1 Takım: 1-2" Tarak



1690 \$

## PR 1003

### 3" TEZGAH TİP PAFTA MAKİNASI

Ölçü	1/2" - 3"
Watt	900 W
Devir Sayısı	2 Devir
Hızlı Devir (F)	20 d/dk
Yavaş Devir (S)	10 d/dk
Voltaj	230 V~50 Hz
Ağırlık	100 Kg



- 3 inch
- 900 Watt
- Otomatik
- 2 Vites

#### Aksesuarlı

- 1 Adet : 2 1/2" - 3" Kafa
- 1 Takım : 1/2" - 3/4" Tarak
- 1 Takım : 2 1/2" - 3" Tarak





1890 \$

**PR 1004**

**4" TEZGAH TİP  
PAFTA MAKİNASI**

Ölçü	1/2" - 4"
Watt	900 W
Devir Sayısı	2 Devir
Hızlı Devir (F)	24 d/dk
Yavaş Devir (S)	8 d/dk
Voltaj	230 V~50 Hz
Ağırlık	125 Kg

**Aksesuarlı**

- 1 Adet : 2<sup>1</sup>/<sub>2</sub>" - 4" Kafa
- 1 Takım : 1/2" - 3/4" Tarak
- 1 Takım : 2<sup>1</sup>/<sub>2</sub>" - 4" Tarak



- 4 inch**
- 900 Watt**
- Otomatik**
- 2 Vites**

**TEZGAH TİP ELEKTRİKLİ PAFTA YEDEK AKSAMLARI**

**PAFTA TARAKLARI / DEMİR VE KROM BORU AÇMA**

Yedek Tarak Takımı (4'lü)	<b>1/2" - 3/4"</b>	50.00 \$
Yedek Tarak Takımı (4'lü)	<b>1" - 2"</b>	50.00 \$
Yedek Tarak Takımı (4'lü)	<b>2.1/2" - 3"</b>	53.00 \$
Yedek Tarak Takımı (4'lü)	<b>2.1/2" - 4"</b>	55.00 \$

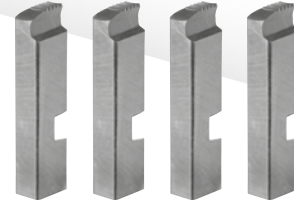

**PAFTA TARAK KAFALARI**

PR 2002 / PR 1002 2" Kafa	<b>1/2" - 2"</b>	135.00 \$
PR 3003 / PR 1003 2" Kafa	<b>1/2" - 2"</b>	145.00 \$
PR 3003 / PR 1003 3" Kafa	<b>2.1/2" - 3"</b>	155.00 \$
PR 4004 / PR 1004 2" Kafa	<b>1/2" - 2"</b>	160.00 \$
PR 4004 / PR 1004 4" Kafa	<b>2.1/2" - 4"</b>	175.00 \$



**BORU KESME BİÇAKLARI**

Boru Kesme Bıçağı	<b>2" için</b>	5.50 \$
Boru Kesme Bıçağı	<b>3" için</b>	5.50 \$
Boru Kesme Bıçağı	<b>4" için</b>	5.50 \$

**PAFTA BORU KESİCİ KOLLARI**

Pafta Boru Kesme Kolu 2"	<b>(Kesici Bıçak İle Birlikte)</b>	95.00 \$
Pafta Boru Kesme Kolu 3"	<b>(Kesici Bıçak İle Birlikte)</b>	120.00 \$
Pafta Boru Kesme Kolu 4"	<b>(Kesici Bıçak İle Birlikte)</b>	140.00 \$

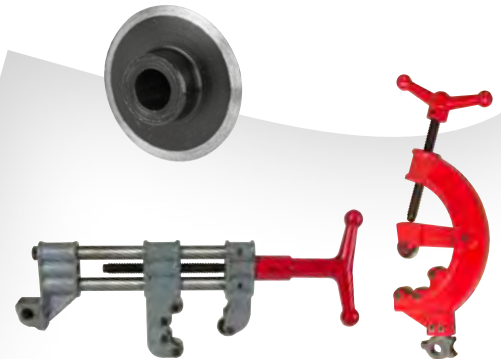

990 \$

## PR 2002

### 2" TEZGAH TİP PAFTA MAKİNASI

Ölçü	1/2" - 2"
Watt	1000 W
Devir Sayısı	1 Devir
Devir Hızı	27 d/dk
Voltaj	230 V~50 Hz
Ağırlık	65 Kg

-  2 inch
-  1000 Watt
-  Otomatik
-  Tezgah Tip



**Aksesuarlı**

- 1 Takım: 1-2" Tarak



1790 \$

## PR 3003

### 3" TEZGAH TİP PAFTA MAKİNASI

Ölçü	1/2" - 3"
Watt	1000 W
Devir Sayısı	2 Devir
Hızlı Devir (F)	24 d/dk
Yavaş Devir (S)	11 d/dk
Voltaj	230 V~50 Hz
Ağırlık	115 Kg

-  3 inch
-  1000 Watt
-  Otomatik
-  2 Vites



**Aksesuarlı**

- 1 Adet : 2 1/2" - 3" Kafa
- 1 Takım : 1/2" - 3/4" Tarak
- 1 Takım : 2 1/2" - 3" Tarak





**Aksesuarlı**

- 1 Adet : 2<sup>1</sup>/<sub>2</sub>" - 4" Kafa
- 1 Takım : 1/2" - 3/4" Tarak
- 1 Takım : 2<sup>1</sup>/<sub>2</sub>" - 4" Tarak



**1980 \$**

**PR 4004**

**4" TEZGAH TİP  
PAFTA MAKİNASI**

Ölçü	1/2" - 4"
Watt	1000 W
Devir Sayısı	2 Devir
Hızlı Devir (F)	22 d/dk
Yavaş Devir (S)	10 d/dk
Voltaj	230 V~50 Hz
Ağırlık	138 Kg

 4 inch

 1000 Watt

 Otomatik

 2 Vites



**Aksesuarlı**



Boru Destek  
Sehpası

**2900 \$**

**PR 2020**

**2"-12" YİV AÇMA  
MAKİNASI**

Ölçü	2" - 12"
Watt	750 W
Devir Sayısı	24 d/dk
Yiv Açma Kapst.	2" - 12" SCH 10 Çeliği Paslanmaz
Yiv Açma Kapst.	2" - 6" SCH 40 Çeliği Paslanmaz
Voltaj	230 V~50 Hz
Ağırlık	120 Kg

 2-12 inch

 TezgaH Tip

1050 \$

## PR 2002 PRO

### 2" TEZGAH TİP PAFTA MAKİNASI

Ölçü	1/2" - 2"
Watt	1000 W
Devir Sayısı	1 Devir
Devir Hızı	28 d/dk
Voltaj	230 V~50 Hz
Ağırlık	65 Kg



- 2 inch
- 1000 Watt
- Otomatik
- TezgaH Tip

#### Aksesuarlı

- 1 Takım: 1-2" Tarak



1850 \$

## PR 3003 PRO

### 3" TEZGAH TİP PAFTA MAKİNASI

Ölçü	1/2" - 3"
Watt	1000 W
Devir Sayısı	2 Devir
Hızlı Devir (F)	20 d/dk
Yavaş Devir (S)	10 d/dk
Voltaj	230 V~50 Hz
Ağırlık	102 Kg



- 3 inch
- 1000 Watt
- Otomatik
- 2 Vites

#### Aksesuarlı

- 1 Adet : 2 1/2" - 3" Kafa
- 1 Takım : 1/2" - 3/4" Tarak
- 1 Takım : 2 1/2" - 3" Tarak



2050 \$



## PR 4004 PRO

### 4" TEZGAH TİP PAFTA MAKİNASI

Ölçü	1/2" - 4"
Watt	1000 W
Devir Sayısı	2 Devir
Hızlı Devir (F)	24 d/dk
Yavaş Devir (S)	8 d/dk
Voltaj	230 V~50 Hz
Ağırlık	128 Kg

### Aksesuarlı

- 1 Adet : 2 1/2" - 4" Kafa
- 1 Takım : 1/2" - 3/4" Tarak
- 1 Takım : 2 1/2" - 4" Tarak



1000 Watt



2 Vites

3300 \$



## PR 2120 PRO

### 2"-12" YİV AÇMA MAKİNASI

Ölçü	2" - 12"
Watt	1100 W
Devir Sayısı	29 d/dk
Yiv Açma Kapst.	2" - 12" SCH 10 Çeliği Paslanmaz
Yiv Açma Kapst.	2" - 6" SCH 40 Çeliği Paslanmaz
Voltaj	230 V~50 Hz
Ağırlık	160 Kg



1100 W



Tezgahtip



Sehpa

### Aksesuarlı



Boru Destek  
Sehpa'sı

750 \$

## PR 1710

### 1/2 - 1.1/4" ELEKTRİKLİ EL TİPİ PAFTA MAKİNASI

Ölçü	1/2" - 1.1/4"
Watt	1700 W
Devir Hızı d/dk	25 (Diş Açma)
Devir Hızı d/dk	25 (Geri Dönüş)
Voltaj	230 V ~ 50 Hz
Ağırlık	6 Kg



#### Aksesuarlı

- 1/2" Kafa + Tarak
- 3/4" Kafa + Tarak
- 1" Kafa + Tarak
- 1.1/4" Kafa + Tarak

1/2"-1.1/4" Çantalı Kit



1050 \$

## PR 1720

### 1/2 - 2" ELEKTRİKLİ EL TİPİ PAFTA MAKİNASI

Ölçü	1/2" - 2"
Watt	1700 W
Devir Hızı d/dk	28-18 (Diş Açma)
Devir Hızı d/dk	51 (Geri Dönüş)
Voltaj	230 V ~ 50 Hz
Ağırlık	8.8 Kg



#### Aksesuarlı

- 1/2" Kafa + Tarak
- 3/4" Kafa + Tarak
- 1" Kafa + Tarak
- 1.1/4" Kafa + Tarak
- 1.1/2" Kafa + Tarak
- 2" Kafa + Tarak

1/2"-2 Çantalı Kit





450 \$

## PR 9252 HP

### 2" HİDROLİK BORU BÜKME MAKİNASI

Ölçü	1/2" - 2"
Maks. Basınç	45 Mpa
Maks. Vuruş	250 mm
Eğme Açısı	90°-180°
Kıvrıma Aralığı	Ø21.3-Ø60 mm
Boru Et Kalınlığı	2.75-3.9 mm
Ağırlık	46 Kg

 2 inch

 Tezgah Tip

#### Aksesuarlı

İçindeki Kalıp Ölçüleri

- 1/2" • 3/4" • 1"
- 1.1/4" • 1.1/2" • 2"



850 \$

## PR 9353 HP

### 3" HİDROLİK BORU BÜKME MAKİNASI

Ölçü	1/2" - 3"
Maks. Basınç	50 Mpa
Maks. Vuruş	290 mm
Eğme Açısı	90°-180°
Kıvrıma Aralığı	Ø21.3-Ø88.5mm
Boru Et Kalınlığı	2.75 - 5 mm
Ağırlık	98 Kg

 3 inch

 Tezgah Tip

#### Aksesuarlı

İçindeki Kalıp Ölçüleri

- 1/2" • 3/4" • 1"
- 1.1/4" • 1.1/2" • 2"
- 2.1/2" • 3"



850 \$

## PR 3200 S

### STANDART SEHPA KAROT MAKİNASI

Watt	3200 W
Delme Çapı	235 mm
Devir Hızı	700 d/dk
Voltaj	230 V ~ 50 Hz
Ağırlık	22 Kg
Sehpa Tipi	Standart

 Standart  3200 Watt



Karot Uç  
opsiyoneldir

900 \$

## PR 3200 A

### AÇILI SEHPA KAROT MAKİNASI

Watt	3200 W
Delme Çapı	235 mm
Devir Hızı	700 d/dk
Voltaj	230 V ~ 50 Hz
Ağırlık	24 Kg
Sehpa Tipi	Açılı

 Açılı  3200 Watt



Karot Uç  
opsiyoneldir



950 \$

## PR 4200 S

### STANDART SEHPA KAROT MAKİNASI

Watt	3200 W
Delme Çapı	235 mm
Devir Hızı	700 d/dk
Voltaj	230 V ~ 50 Hz
Ağırlık	25 Kg
Sehpa Tipi	Standart



1025 \$

## PR 4200 A

### AÇILI SEHPA KAROT MAKİNASI

Watt	3200 W
Delme Çapı	235 mm
Devir Hızı	700 d/dk
Voltaj	230 V ~ 50 Hz
Ağırlık	27 Kg
Sehpa Tipi	Açılı



1325 \$

## PR 2600 S

### STANDART SEHPA KAROT MAKİNASI

Watt	3200 W
Delme Çapı	255 mm
Vites Sayısı	2 vites
1.Vites	500 d/dk
2.Vites	920 d/dk
Voltaj	220 V
Ağırlık	34 Kg
Sehpa Tipi	Standart

 Standart  2 Vites



Karot Uç  
opsiyoneldir

1475 \$

## PR 2600 A

### AÇILI SEHPA KAROT MAKİNASI

Watt	3200 W
Delme Çapı	255 mm
Vites Sayısı	2 vites
1.Vites	500 d/dk
2.Vites	920 d/dk
Voltaj	220 V
Ağırlık	46 Kg
Sehpa Tipi	Açılı

 Açılı  2 Vites



Karot Uç  
opsiyoneldir

**PROFESSIONAL** **ELMAS DELİCİ KAROT UÇLARI / Sulu Kesim**



**PROTER**

**PROTER**

SULU KESİM	UZUNLUK	DELME ÇAPI	Koli Adet	Birim Fiyat
Elmas Delici Karot Ucu	550 mm	<b>25 mm</b>	15	<b>48.00 \$</b>
Elmas Delici Karot Ucu	550 mm	<b>30 mm</b>	15	<b>50.00 \$</b>
Elmas Delici Karot Ucu	550 mm	<b>40 mm</b>	15	<b>60.00 \$</b>
Elmas Delici Karot Ucu	550 mm	<b>50 mm</b>	15	<b>65.00 \$</b>
Elmas Delici Karot Ucu	550 mm	<b>63 mm</b>	15	<b>72.00 \$</b>
Elmas Delici Karot Ucu	550 mm	<b>71 mm</b>	10	<b>85.00 \$</b>
Elmas Delici Karot Ucu	550 mm	<b>76 mm</b>	10	<b>90.00 \$</b>
Elmas Delici Karot Ucu	550 mm	<b>83 mm</b>	10	<b>97.00 \$</b>
Elmas Delici Karot Ucu	550 mm	<b>89 mm</b>	10	<b>105.00 \$</b>
Elmas Delici Karot Ucu	550 mm	<b>102 mm</b>	8	<b>115.00 \$</b>
Elmas Delici Karot Ucu	550 mm	<b>110 mm</b>	8	<b>120.00 \$</b>
Elmas Delici Karot Ucu	550 mm	<b>127 mm</b>	8	<b>130.00 \$</b>
Elmas Delici Karot Ucu	550 mm	<b>132 mm</b>	6	<b>140.00 \$</b>
Elmas Delici Karot Ucu	550 mm	<b>150 mm</b>	6	<b>170.00 \$</b>
Elmas Delici Karot Ucu	550 mm	<b>160 mm</b>	6	<b>180.00 \$</b>
Elmas Delici Karot Ucu	550 mm	<b>202 mm</b>	4	<b>255.00 \$</b>

380 \$

## PR 2200 S

### EL TİPİ KAROT MATKAP

Watt	1700 W
Delme Çapı	100 mm
Vites Sayısı	3 Vites
1.Vites	900 d/dk
2.Vites	1990 d/dk
3.Vites	4300 d/dk
Ağırlık	6.5 Kg

 1700 Watt  3 Vites

 100 mm  80 mm



#### MAX. DELME ÇAPI

TUĞLA ve benzeri ( 100 mm )

- 1.Vites / 100 mm Delme Çapı
- 2.Vites / 80 mm Delme Çapı
- 3.Vites / 50 mm Delme Çapı

#### MAX. DELME ÇAPI

BETONARME'DE ( 80 mm )

- 1.Vites / 80 mm Delme Çapı
- 2.Vites / 50 mm Delme Çapı
- 3.Vites / 25 mm Delme Çapı

680 \$

## PR 2200 ST

### EL TİPİ SEHPALI KAROT MATKAP

Watt	1700 W
Delme Çapı	100 mm
Vites Sayısı	3 Vites
1.Vites	900 d/dk
2.Vites	1990 d/dk
3.Vites	4300 d/dk
Ağırlık	6.5 Kg

 1700 Watt  3 Vites

 100 mm  80 mm



#### 1 MAKİNADA 4 İŞLEM

- \* Sehpa İle Kullanım
- \* El İle Kullanım
- \* Sulu Delme
- \* Kuru Delme

YEDEK KAROT MOTORU VE KIZAĞI		YEDEK KAROT SEHPALARI	
PR 2600 KAROT MOTORU	PR 2600 KAYDIRMA KIZAĞI	PR 2600 S STANDART	PR 2600 A AÇILI
			
950 \$	130 \$	420 \$	600 \$

YEDEK KAROT MOTORU VE KIZAĞI		YEDEK KAROT SEHPALARI	
PR 4200 KAROT MOTORU	PR 4200 KAYDIRMA KIZAĞI	PR 4200 S STANDART	PR 4200 A AÇILI
			
600 \$	100 \$	400 \$	500 \$

YEDEK KAROT MOTORU VE KIZAĞI		YEDEK KAROT SEHPALARI	
PR 3200 KAROT MOTORU	PR 3200 KAYDIRMA KIZAĞI	PR 3200 S STANDART	PR 3200 A AÇILI
			
600 \$	100 \$	300 \$	375 \$

Yüksek Performans  
**Ekonomik**  
Hızlı Servis



# Üstün Kalite

Ergonomik

Tasarım



50 \$

## PST 107 Kit

### ŞARJLI VİDALAMA TORNAVİDA SET

Volt	7.2 V
Akü Amper	1.3 Ah / Li-ion
Tork Adedi	5 kademe
Max. Tork Gücü	10 N.m
Elektronik Hız	0-230 d/dk
Dönüş Yönü	Sağ - Sol
Şarj Süresi	1.5 Saat / Hızlı
Mandren Tipi	1/4"



Li-ion Pili

### Aksesuar Hediye

- 6 Ad. bits uç
- 1 Ad. uzatma adaptörü

7.2 V

1.3 Ah



180 \$

## PST 927 SC

### ŞARJLI ALÇIPAN VİDALAMA

Vidalama Uç Çapı	6.35 mm / 1/4"
Volt	20 V
Akü Amper	2.0 Ah / Li-ion
Max. Tork Gücü	25 N.m
Elektronik Hız	0-4200 d/dk
Dönüş Yönü	Sağ - Sol
Şarj Süresi	1.5 Saat / Hızlı



Li-ion Pili

20 V

2.0 Ah

25 Nm

1/4" Hex



52 Parça  
Kit



Li-ion Pili

105 \$

## PST 352 Kit

### ŞARJLI VİDALAMA 52 PARÇA SET

Akü Amper	2.0 Ah / Li-ion
Volt	12.0 V
Mandren Çapı	10 mm
Tork Adedi	18 kademe + 3
Max. Tork Gücü	30 N.m
Elektronik Hız	1.Vites 0-350 d/dk
Elektronik Hız	2.Vites 0-1350 d/dk
Dönüş Yönü	Sağ - Sol
Şarj Süresi	1.5 Saat / Hızlı

 12.0 V

 2.0 Ah

 2 Vites

 2 Akü



Li-ion Pili

110 \$

## PST 920 SP

### ŞARJLI MATKAP 10 MM

Volt	20 V
Akü Amper	2.0 Ah / Li-ion
Mandren Çapı	10 mm
Tork Adedi	25 Kademe
Max. Tork Gücü	32 N.m
Elektronik Hız	1.Vites 0-350 d/dk
Elektronik Hız	2.Vites 0-1350 d/dk
Dönüş Yönü	Sağ - Sol
Şarj Süresi	1.5 Saat / Hızlı

 20 V

 2.0 Ah

 2 Akü

 2 Vites



110 \$

## PST 222 Plus

### ŞARJLI VİDALAMA TORNAVİDA

Akü Amper	2.0 Ah / Li-ion
Volt	12.0 V
Mandren Çapı	10 mm
Tork Adedi	18 kademe
Max. Tork Gücü	30 N.m
Elektronik Hız	1.Vites 0-400 d/dk
Elektronik Hız	2.Vites 0-1400 d/dk
Dönüş Yönü	Sağ - Sol
Şarj Süresi	1.5 Saat / Hızlı



- 12.0 V
- 2.0 Ah
- 2 Vites
- 2 Akü



150 \$

## PST 145 T

### TORKLU DARBELİ ŞARJLI VİDALAMA / TORNAVİDA

Tork Gücü	145 N.m
Volt	18.0 V
Akü Amper	2.0 Ah / Li-ion
Soket Çapı	1/4"
Elektronik Hız	0-2400 d/dk
Darbe Sayısı	0-3000 d/dk
Dönüş Yönü	Sağ - Sol
Şarj Süresi	1.5 Saat / Hızlı



- 2.0 Ah
- 145 N.m Tork
- 2 Akü
- Led Işıklı





140 \$

## PST 614 LD

### DARBELİ 10 MM ŞARJLI MATKAP

Volt	14.4 V
Akü Amper	2.0 Ah / Li-ion
Mandren Çapı	10 mm
Tork Adedi	19 Kademe
Max. Tork Gücü	32 N.m
Elektronik Hız	1.Vites 0-400 d/dk
Elektronik Hız	2.Vites 0-1400 d/dk
Dönüş Yönü	Sağ - Sol
Şarj Süresi	1.5 Saat / Hızlı

 2.0 Ah

 2 Vites

 2 Akü

 Led Işıklı



150 \$

## PST 618 LD

### DARBELİ 10 MM ŞARJLI MATKAP

Volt	18.0 V
Akü Amper	2.0 Ah / Li-ion
Mandren Çapı	10 mm
Tork Adedi	19 Kademe
Max. Tork Gücü	35 N.m
Elektronik Hız	1.Vites 0-400 d/dk
Elektronik Hız	2.Vites 0-1400 d/dk
Dönüş Yönü	Sağ - Sol
Şarj Süresi	1.5 Saat / Hızlı

 2.0 Ah

 2 Vites

 2 Akü

 Led Işıklı



175 \$

## PST 500 SD

### ŞARJLI DEKUPAJ MAKİNASI

Akü Amper	2.0 Ah / Li-ion
Volt	20 V
Elektronik Hız	0 - 2400 d/dk
Max. Kesim	65 mm
Pandül Hareketi	4 Kademe
Şarj Süresi	1.5 Saat / Hızlı



2.0 Ah

2 Akü



275 \$

## PST 585 BC

### ŞARJLI SUNTA KESME MAKİNASI

Testere Çapı	185 mm
Akü Amper	5.0 Ah/Li-ion
Volt	20 V
Devir Hızı	5100 d/dk
Kesim Derinliği (90°)	60 mm
Açılı Kes. Der. (45°)	45 mm
Şarj Süresi	2 Saat/Hızlı



5.0 Ah

185 mm

2 Akü

20 V





155 \$

## PST 414 SL

### ŞARJLI MATKAP 13 MM

Volt	14.4 V
Akü Amper	2.0 Ah / Li-ion
Mandren Çapı	13 mm
Tork Adedi	18 Kademe
Max. Tork Gücü	43 N.m
Elektronik Hız	1.Vites 0-400 d/dk
Elektronik Hız	2.Vites 0-1500 d/dk
Dönüş Yönü	Sağ - Sol
Şarj Süresi	1.5 Saat / Hızlı

 2.0 Ah

 2 Vites

 2 Akü

 Led Işıklı



170 \$

## PST 418 SL

### ŞARJLI MATKAP 13 MM

Volt	18.0 V
Akü Amper	2.0 Ah / Li-ion
Mandren Çapı	13 mm
Tork Adedi	18 Kademe
Max. Tork Gücü	45 N.m
Elektronik Hız	1.Vites 0-400 d/dk
Elektronik Hız	2.Vites 0-1500 d/dk
Dönüş Yönü	Sağ - Sol
Şarj Süresi	1.5 Saat / Hızlı

 2.0 Ah

 2 Vites

 2 Akü

 Led Işıklı



250 \$

## PST 364 T

### KÖMÜRSÜZ DARBELİ ŞARJLI TORNAVİDA

Soket Çapı	1/4"
Max. Tork Gücü	350 N.m
Akü Amper	4.0 Ah / Li-ion
Volt	20.0 V
Hız Ayarı (S)	0-1600/2000/2600 d/dk
Dönüş Yönü	Sağ - Sol
Şarj Süresi	1.5 Saat / Hızlı

- 4.0 Ah
- 350 N.m Tork
- 2 Akü
- Led Işıklı



350 N.m TORK

4.0 Ah  
Amper

Darbeli

Kömürsüz

Dijital Hız Ayarlı



Li-ion Pili

260 \$

## PST 460 WS

### KÖMÜRSÜZ DARBELİ ŞARJLI SOMUN SÖKME

Soket Çapı	1/2"
Max. Tork Gücü	350 N.m
Akü Amper	4.0 Ah / Li-ion
Volt	20.0 V
Hız Ayarı (S)	0-1600/2000/2600 d/dk
Dönüş Yönü	Sağ - Sol
Şarj Süresi	1.5 Saat / Hızlı

- 4.0 Ah
- 350 N.m Tork
- 2 Akü
- Led Işıklı



350 N.m TORK

4.0 Ah  
Amper

Kömürsüz

Darbeli

Dijital Hız Ayarlı



Li-ion Pili

220 \$



## PST 720 BL

### KÖMÜRSÜZ DARBELİ 13 mm ŞARJLI MATKAP

Akü Amper	2.0 Ah / Li-ion
Volt	20.0 V
Mandren Çapı	13 mm
Tork Adedi	21 Kademe
Max. Tork Gücü	62 N.m
Elektronik Hız	1. Vites 0-450d/dk
Elektronik Hız	2. Vites 0-2000d/dk
Dönüş Yönü	Sağ - Sol
Şarj Süresi	1.5 Saat / Hızlı

 2.0 Ah

 20.0 V

 2 Vites

 2 Akü



260 \$



## PST 740 BL

### KÖMÜRSÜZ DARBELİ 13 mm ŞARJLI MATKAP

Akü Amper	4.0 Ah / Li-ion
Volt	20.0 V
Mandren Çapı	13 mm
Tork Adedi	21 Kademe
Max. Tork Gücü	62 N.m
Elektronik Hız	1. Vites 0-450d/dk
Elektronik Hız	2. Vites 0-2000d/dk
Dönüş Yönü	Sağ - Sol
Şarj Süresi	1.5 Saat / Hızlı

 4.0 Ah

 20.0 V

 2 Vites

 2 Akü



190 \$

## PST 522 BL

### KÖMÜRSÜZ DARBELİ 10 mm ŞARJLI MATKAP

Akü Amper	2.0 Ah / Li-ion
Volt	20 V
Mandren Çapı	10 mm
Tork Adedi	20 Kademe
Max. Tork Gücü	45 N.m
Elektronik Hız	1.Vites 0-420 d/dk
Elektronik Hız	2.Vites 0-1400 d/dk
Dönüş Yönü	Sağ - Sol
Şarj Süresi	1.5 Saat / Hızlı

**P** 2.0 Ah

**P** 2 Vites

**P** 2 Akü

**P** Led Işıklı



### **P** Aksesuar Hedyeli

- 6 Ad. bits uç
- 6 Ad. delici uç
- 1 Ad. uzatma adap.

**Li-ion Pil**

230 \$

## PST 544 BL

### KÖMÜRSÜZ DARBELİ 10 mm ŞARJLI MATKAP

Akü Amper	4.0 Ah / Li-ion
Volt	20 V
Mandren Çapı	10 mm
Tork Adedi	20 Kademe
Max. Tork Gücü	45 N.m
Elektronik Hız	1.Vites 0-420 d/dk
Elektronik Hız	2.Vites 0-1400 d/dk
Dönüş Yönü	Sağ - Sol
Şarj Süresi	1.5 Saat / Hızlı

**P** 4.0 Ah

**P** 2 Vites

**P** 2 Akü

**P** Led Işıklı



### **P** Aksesuar Hedyeli

- 6 Ad. bits uç
- 6 Ad. delici uç
- 1 Ad. uzatma adap.

**Li-ion Pil**

250 \$



## PST 504 AG

### ŞARJLI AVUÇ TAŞLAMA MAKİNASI

Akü Amper	4.0 Ah / Li-ion
Volt	20.0 V
Disk Çapı	115 mm
Devir Hızı	10.000 d/dk
Mil Çapı	M14
Şarj Süresi	1.5 Saat / Hızlı

 2 Akü

 Çantalı Kit



270 \$



## PST 905 E

### ŞARJLI AVUÇ TAŞLAMA MAKİNASI

Akü Amper	5.0 Ah / Li-ion
Volt	20.0 V
Disk Çapı	115 mm
Devir Hızı	0-8500 d/dk
Mil Çapı	M14
Şarj Süresi	2 Saat / Hızlı

 Dijital Hız Ayarlı

 2 Akü

 Çantalı Kit



260 \$

## PST 945 HD

### ŞARJLI PNOMATİK KIRICI - DELİCİ

Akü Amper	4.0 Ah / Li-ion
Volt	20.0 V
Vuruş Gücü	2.2 Joule
Kırma Hızı	0 - 5000 d/dk
Delme Hızı	0 - 1200 d/dk
Delme Çapı	22 mm (Duvar)
Delme Çapı	28 mm (Ahşap)
Dönüş Yönü	Sağ - Sol
Şarj Süresi	1.5 Saat / Hızlı
Mandren Tipi	S. Plus



4.0 Ah  
Amper

Kömürsüz

Li-ion Pil



4.0 Ah 20.0 V Darbeli

2 Akü Led Işıklı Çantalı Kit

Aksesuar Hediyeli

• 3 Ad. plus uç hediyeli

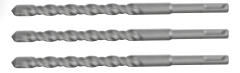

285 \$

## PST 950 HD

### ŞARJLI PNOMATİK KIRICI - DELİCİ

Akü Amper	5.0 Ah / Li-ion
Volt	20.0 V
Vuruş Gücü	2.2 Joule
Kırma Hızı	0 - 5000 d/dk
Delme Hızı	0 - 1200 d/dk
Delme Çapı	22 mm (Duvar)
Delme Çapı	28 mm (Ahşap)
Dönüş Yönü	Sağ - Sol
Şarj Süresi	2 Saat / Hızlı
Mandren Tipi	S. Plus



5.0 Ah  
Amper

Kömürsüz

Li-ion Pil



5.0 Ah 20.0 V Darbeli

2 Akü Led Işıklı Çantalı Kit

Aksesuar Hediyeli

• 3 Ad. plus uç hediyeli



275 \$

## PST 870 HD

### ŞARJLI PNOMATİK KIRICI - DELİCİ

Akü Amper	4.0 Ah / Li-ion
Volt	20.0 V
Vuruş Gücü	2.7 Joule
Kırma Hızı	0 - 4000 d/dk
Delme Hızı	0 - 1100 d/dk
Delme Çapı	22 mm (Düvar)
Delme Çapı	28 mm (Ahşap)
Dönüş Yönü	Sağ - Sol
Şarj Süresi	1.5 Saat / Hızlı
Mandren Tipi	S. Plus



4.0 Ah  
Amper

Kömürsüz

 Li-ion Pili



### Aksesuar Hediye

- 3 Ad. plus uç hediye



 4.0 Ah

 20.0 V

 Darbeli

 2 Akü

 Led Işıklı

 Çantalı Kit

295 \$

## PST 875 HD

### ŞARJLI PNOMATİK KIRICI - DELİCİ

Akü Amper	5.0 Ah / Li-ion
Volt	20.0 V
Vuruş Gücü	2.7 Joule
Kırma Hızı	0 - 4000 d/dk
Delme Hızı	0 - 1100 d/dk
Delme Çapı	22 mm (Düvar)
Delme Çapı	28 mm (Ahşap)
Dönüş Yönü	Sağ - Sol
Şarj Süresi	2 Saat / Hızlı
Mandren Tipi	S. Plus



5.0 Ah  
Amper

Kömürsüz

 Li-ion Pili



### Aksesuar Hediye

- 3 Ad. plus uç hediye

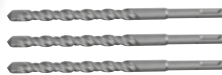

 5.0 Ah

 20.0 V

 Darbeli

 2 Akü

 Led Işıklı

 Çantalı Kit

420 \$

## PST 903 Trio

### ŞARJLI 3'LÜ SET

- \* PST 945 HD 4 Ah Kırcı Delici
- \* PST 904 E 4 Ah Avuç Taşlama
- \* PST 924 BL 4 Ah Darbeli Matkap



3 Akülü Hızlı Şarj



4.0 Ah

Li-ion Pil

Kömürsüz Motor

440 \$

## PST 913 Trio

### ŞARJLI 3'LÜ SET

- \* PST 904 E 4 Ah Avuç Taşlama
- \* PST 945 HD 4 Ah Kırcı Delici
- \* PST 964 WS 4 Ah Somun Sökme



3 Akülü Hızlı Şarj



4.0 Ah

Li-ion Pil

Kömürsüz Motor

490 \$

## PST 914 quatro

### ŞARJLI 4'LÜ SET

- \* PST 945 HD 4 Ah Kırıcı Delici
- \* PST 904 E 4 Ah Avuç Taşlama
- \* PST 964 WS 4 Ah Somun Sökme
- \* PST 924 BL 4 Ah Darbeli Matkap



 3 Akülü

 Hızlı Şarj



 4.0 Ah

 Li-ion Pili

**Kömürsüz Motor**



530 \$

## PST 1914 quatro

### ŞARJLI 4'LÜ SET

- \* 4 Ah Kırıcı Delici
- \* 4 Ah Avuç Taşlama
- \* 4 Ah Vidalama
- \* 4 Ah Dekupaj Makinası



 3 Akülü

 Hızlı Şarj



 4.0 Ah

 Li-ion Pili

**Kömürsüz Motor**



135 \$

## PST 115 ST

### ŞARJLI ZİNCİRLİ BUDAMA TESTERESİ

Max. Kesim Çapı	150 mm
Akü Amper	2.0 Ah / Li-ion
Volt	20.0 V
Devir Hızı	3500 d/dk
Kesme Hızı	6.5 m/s
Ağırlık	1.35 Kg
Şarj Süresi	1.5 Saat / Hızlı

 2 Akü

 Çantalı Kit



 Yedek Zincir



150 mm

Manuel  
Yağlama

Kömürsüz

2.0 Ah  
Amper

Li-ion Pil

175 \$

## PST 120 ST

### ŞARJLI ZİNCİRLİ BUDAMA TESTERESİ

Max. Kesim Çapı	200 mm
Akü Amper	4.0 Ah / Li-ion
Volt	20.0 V
Devir Hızı	4800 d/dk
Kesme Hızı	8 m/s
Ağırlık	1.2 Kg
Şarj Süresi	1.5 Saat / Hızlı

 2 Akü

 Çantalı Kit



 Yedek Zincir



200 mm

Pratik Zincir  
Ayarlama

Manuel  
Yağlama

4.0 Ah  
Amper

Kömürsüz

Li-ion Pil

225 \$

## PST 125 ST

### ŞARJLI ZİNCİRLİ DAL KESME

Max. Kesim Çapı	250 mm
Akü Amper	4.0 Ah / Li-ion
Volt	20.0 V
Devir Hızı	4200 d/dk
Kesme Hızı	7.5 m/s
Ağırlık	2.6 Kg
Şarj Süresi	1.5 Saat / Hızlı



250 mm

Li-ion Pil

Pratik Zincir  
Ayarlama

Kömürsüz

Otomatik  
Yağlama

4.0 Ah  
Amper

 Yedek Zincir



275 \$

## PST 140 STX

### ŞARJLI ZİNCİRLİ ÇİFT AKÜLÜ DAL KESME

Max. Kesim Çapı	400 mm
Akü Amper	4.0 Ah / Li-ion
Volt	40.0 V
Devir Hızı	7200 d/dk
Kesme Hızı	14 m/s
Ağırlık	3.3 Kg
Şarj Süresi	1.5 Saat / Hızlı

40 Volt

400 mm

Li-ion Pil

2 Akü  
Çalışma

Pratik Zincir  
Ayarlama

Kömürsüz

Otomatik  
Yağlama

4.0 Ah  
Amper

 Yedek Zincir



170 \$

## PST 130 BL

### ŞARJLI BUDAMA MAKASI

Max. Kesim Çapı	28 mm 1. Kademe
Max. Kesim Çapı	15 mm 2. Kademe
Volt	16.8 V
Akü Amper	2.0 Ah / Li-ion
Devir Hızı	22.500 d/dk
Çalışma Süresi	3-4 Saat
Ağırlık	0.9 Kg
Şarj Süresi	1.5 Saat / Hızlı



Çantalı Kit



Yedek Bıçak

Ⓟ Kömürsüz Ⓟ 28 mm

Ⓟ 2.0 Ah Ⓟ 2 Akü



180 \$

## PST 230 BL

### ŞARJLI BUDAMA MAKASI

Max. Kesim Çapı	30 mm 1. Kademe
Max. Kesim Çapı	15 mm 2. Kademe
Volt	16.8 V
Akü Amper	2.0Ah / Li-ion
Devir Hızı	23.000 d/dk
Çalışma Süresi	3-4 Saat
Ağırlık	0.90 Kg
Şarj Süresi	1.5 Saat / Hızlı



Çantalı Kit



Yedek Bıçak

Ⓟ Kömürsüz Ⓟ 30 mm

Ⓟ 2.0 Ah Ⓟ 2 Akü



215 \$

## PST 140 BL

### ŞARJLI BUDAMA MAKASI

Max. Kesim Çapı	40 mm / 30 mm
Max. Kesim Çapı	20 mm / 10 mm
Volt	20.0 V
Akü Amper	4.0 Ah / Li-ion
Devir Hızı	23.000 d/dk
Çalışma Süresi	3-4 Saat
Ağırlık	1.6 Kg
Şarj Süresi	1.5 Saat / Hızlı

40 mm  
4.0 Ah  
Amper  
Kömürsüz



Li-ion Pili



Çantalı Kit

Yedek Bıçak

Ⓟ Kömürsüz Ⓟ 40 mm

Ⓟ 4.0 Ah Ⓟ 2 Akü



225 \$

## PST 565 HT

### ŞARJLI ÇİT BUDAMA MAKİNESİ

Pala Boyu	50-52 cm
Akü Amper	4.0 Ah / Li-ion
Volt	20 V
Devir Hızı	1400 d/dk
Max. Kesim Çap	15 mm
Ağırlık	2.7 Kg
Şarj Süresi	1.5 Saat / Hızlı



Li-ion Pili

4.0 Ah  
Amper

52 cm  
Kesim

Ⓟ 4.0 Ah Ⓟ 2 Akü

Ⓟ 52 cm Ⓟ Ergonomik



145 \$

## PST 935 BS

### ŞARJLI ÜFLEYİCİ (HIZ AYARLI)

Akü Amper	2.0 Ah / Li-ion
Volt	20.0 V
Elektronik Hız	0-19.000 d/dk
Hava Akımı	0-2.6 m³
Şarj Süresi	1.5 Saat / Hızlı
Ağırlık	1.45 Kg



Li-ion Pili

2.0 Ah

2 Akü

20.0 Volt

Devir Ayarlı



165 \$

## PST 934 HG

### ŞARJLI SICAK HAVA TABANCASI

Akü Amper	4.0 Ah / Li-ion
Volt	20.0 V
Sıcaklık Ayarı	350° - 550°
Fan Kapasite	100-200 lt d/dk
Şarj Süresi	1.5 Saat / Hızlı
Ağırlık	1.1 Kg



Li-ion Pili



4.0 Ah

Fan Ayarlı

2 Akü

Isı Ayarlı



170 \$



Dijital Gösterge / 6 Kademe Dijital Hız Ayarlı

## PST 215 TF

### VANTUZLU TİTREŞİMLİ FAYANS TOKMAK

Taban Çapı	150 mm
Akü Amper	2.0 Ah / Li-ion
Volt	16.8 V
Devir Hızı	20.000 d/dk
Max. Taşıma	50 Kg
Şarj Süresi	1.5 Saat / Hızlı
Ağırlık	2.1 Kg

 2.0 Ah

 2 Akü

 Vakumlu

 Titreşim Ayarlı



225 \$



TEK MAKİNA **2** ÖZELLİK



Kartuş  
Tabancası

Sosis  
Tabancası

Devir  
Ayarlı

Tetik  
Sabitleme

## PST 960 GS

### ŞARJLI KARTUŞ & SOSİS SİLİKON TABANCASI

Kartuş Kapasitesi	600 ml
Akü Amper	2.0 Ah / Li-ion
Volt	20.0 V
İtme Hızı	0 - 9.5 mm/s
İtme Gücü	6500 N.m
Şarj Süresi	1.5 Saat / Hızlı
Ağırlık	2.1 Kg

 2.0 Ah

 2 Akü

 20.0 V

 Devir Ayarlı



58 \$

## PST 232

### ŞARJLI LASTİK ŞİŞİRME

Volt	12.0 V
Akü Amper	2.0 Ah / Li-ion
Max. Basınç	150 Psi
Hava Debi	23 Lt d/dk
Çalışma Süresi	30 Dk
Şarj Süresi	3 Saat



**Dijital Gösterge**

**2 Adet Şişirme Adaptörü**



170 \$

## PST 938 WP

### ŞARJLI OTO YIKAMA MAKİNASI

Akü Amper	4.0 Ah / Li-ion
Volt	20.0 V
Max. Bar	20 Bar
Su Sevk Miktarı	4.5 Lt / dk
Şarj Süresi	1.5 Saat / Hızlı

6 Fonksiyon Püskürtme



Dijital Basınç Ayarlı & Şarj Göstergesi

4.0 Ah  
Amper

Taşıma  
Çantalı

Kovadan  
Su Çekme

Li-ion Pili

**4.0 Ah**

**2 Akü**

**20 Bar**

**Basınç Ayarlı**



**5 m. Hortum**

PST 352 Kit	Akü	35.00 \$
PST 352 Kit	Şarj Adaptörü	15.00 \$
PST 107 Kit	Şarj Adaptörü	12.00 \$
PST 145 T	Akü	40.00 \$
PST 145 T	Şarj Adaptörü	15.00 \$
PST 222 Plus	Akü	35.00 \$
PST 222 Plus	Şarj Adaptörü	15.00 \$
PST 614 LD	Akü	35.00 \$
PST 614 LD	Şarj Adaptörü	15.00 \$
PST 618 LD	Akü	40.00 \$
PST 618 LD	Şarj Adaptörü	15.00 \$
PST 360 T	Akü	50.00 \$
PST 360 T	Şarj Cihazı	30.00 \$
PST 364 T	Akü	80.00 \$
PST 364 T	Şarj Cihazı	35.00 \$
PST 414 SL	Akü	40.00 \$
PST 414 SL	Şarj Cihazı	30.00 \$
PST 418 SL	Akü	45.00 \$
PST 418 SL	Şarj Cihazı	30.00 \$
PST 460 WS	Akü	80.00 \$
PST 460 WS	Şarj Cihazı	35.00 \$
PST 720 BL	Akü	50.00 \$
PST 720 BL	Şarj Cihazı	35.00 \$
PST 740 BL	Akü	80.00 \$
PST 740 BL	Şarj Cihazı	35.00 \$
PST 500 SD	Akü	50.00 \$
PST 500 SD	Şarj Cihazı	30.00 \$
PST 504 AG	Akü	80.00 \$
PST 504 AG	Şarj Cihazı	35.00 \$
PST 505 AG	Akü	95.00 \$
PST 505 AG	Şarj Cihazı	35.00 \$
PST 515 AG	Akü	95.00 \$
PST 515 AG	Şarj Cihazı	35.00 \$
PST 522 BL	Akü	50.00 \$
PST 522 BL	Şarj Cihazı	30.00 \$
PST 540 BL	Akü	80.00 \$
PST 540 BL	Şarj Cihazı	35.00 \$
PST 544 BL	Akü	80.00 \$
PST 544 BL	Şarj Cihazı	35.00 \$
PST 550 BL	Akü	95.00 \$
PST 550 BL	Şarj Cihazı	35.00 \$
PST 870 HD	Akü	80.00 \$
PST 870 HD	Şarj Cihazı	35.00 \$
PST 875 HD	Akü	95.00 \$
PST 875 HD	Şarj Cihazı	35.00 \$
PL 1360 LD	Akü	25.00 \$
PL 1360 LD	Şarj Cihazı	20.00 \$
PL 1460 LD	Akü	25.00 \$
PL 1460 LD	Şarj Cihazı	20.00 \$
PL 360 LS	Akü	25.00 \$
PL 360 LS	Şarj Adaptörü	15.00 \$
PL 460 LS	Akü	25.00 \$
PL 460 LS	Şarj Adaptörü	15.00 \$



PST 904 E	Akü	80.00 \$
PST 904 E	Şarj Cihazı	35.00 \$
PST 905 E	Akü	95.00 \$
PST 905 E	Şarj Cihazı	35.00 \$
PST 920 SP	Akü	40.00 \$
PST 920 SP	Şarj Cihazı	30.00 \$
PST 938 WP	Akü	80.00 \$
PST 938 WP	Şarj Cihazı	35.00 \$
PST 935 BS	Akü	50.00 \$
PST 935 BS	Şarj Cihazı	30.00 \$
PST 940 HD	Akü	80.00 \$
PST 940 HD	Şarj Cihazı	40.00 \$
PST 945 HD	Akü	80.00 \$
PST 945 HD	Şarj Cihazı	35.00 \$
PST 950 HD	Akü	95.00 \$
PST 950 HD	Şarj Cihazı	35.00 \$
PST 960 GS	Akü	50.00 \$
PST 960 GS	Şarj Cihazı	30.00 \$
PST 565 HT	Akü	80.00 \$
PST 565 HT	Şarj Cihazı	35.00 \$
PST 1512 WS	Akü	85.00 \$
PST 1512 WS	Şarj Cihazı	35.00 \$
PST 1522 WS	Akü	85.00 \$
PST 1522 WS	Şarj Cihazı	35.00 \$
PST 1532 WS	Akü	85.00 \$
PST 1532 WS	Şarj Cihazı	35.00 \$
PST 110 ST	Akü	40.00 \$
PST 110 ST	Şarj Adaptörü	15.00 \$
PST 115 ST	Akü	40.00 \$
PST 115 ST	Şarj Adaptörü	15.00 \$
PST 120 ST	Akü	70.00 \$
PST 120 ST	Şarj Cihazı	30.00 \$
PST 125 ST	Akü	80.00 \$
PST 125 ST	Şarj Cihazı	35.00 \$
PST 140 STX	Akü	80.00 \$
PST 140 STX	Şarj Cihazı	35.00 \$
PST 130 BL	Akü	40.00 \$
PST 130 BL	Şarj Adaptörü	20.00 \$
PST 132 BL	Akü	40.00 \$
PST 132 BL	Şarj Adaptörü	20.00 \$
PST 232 BL	Akü	40.00 \$
PST 232 BL	Şarj Adaptörü	20.00 \$
PST 140 BL	Akü	80.00 \$
PST 140 BL	Şarj Cihazı	30.00 \$
PST 585 BL	Akü	95.00 \$
PST 585 BL	Şarj Cihazı	35.00 \$
PST 934 HG	Akü	50.00 \$
PST 934 HG	Şarj Cihazı	30.00 \$
PST 215 TF	Akü	50.00 \$
PST 215 TF	Şarj Cihazı	30.00 \$
PST 927 BL	Akü	80.00 \$
PST 927 BL	Şarj Cihazı	35.00 \$



4V SMART

40M

READ

OFF CLEAR

PRO

READ

Laser Distance Meter

PROTEN



**PROTER®**

**Üstün Kalite**  
Ergonomik Tasarım

Yeşil Lazer



Yeşil Lazer



Yeşil Lazer



95 \$

## PL 50 GL

**LAZER METRE / 50 m**  
(Yeşil Lazerli)

Ölçüm Mesafesi	0.05 - 50 M
Ölçüm Hassasiyeti	± 2 mm
Ölçüm Birimleri	M / in / ft
Lazer Tipi	λ: 500-535nm≤1mw
Lazer Sınıfı	Class II
Max. Hafıza Kayıt	99 Kayıt
Sürekli Ölçüm	Evet
Alan Hesaplama	Evet
Hacim Hesaplama	Evet
Pisagor Ölçümü	Evet
Toplama/Çıkarma	Evet
Pil Tipi	3x1.5V AAA
Ölçüler	117x50x25 mm
Ağırlık	140 gr

105 \$

## PL 70 GL

**LAZER METRE / 70 m**  
(Yeşil Lazerli)

Ölçüm Mesafesi	0.05 - 70 M
Ölçüm Hassasiyeti	± 2 mm
Ölçüm Birimleri	M / in / ft
Lazer Tipi	λ: 500-535nm≤1mw
Lazer Sınıfı	Class II
Max. Hafıza Kayıt	99 Kayıt
Sürekli Ölçüm	Evet
Alan Hesaplama	Evet
Hacim Hesaplama	Evet
Pisagor Ölçümü	Evet
Toplama/Çıkarma	Evet
Pil Tipi	3x1.5V AAA
Ölçüler	117x50x25 mm
Ağırlık	140 gr

125 \$

## PL 100 GL

**LAZER METRE / 100 m**  
(Yeşil Lazerli)

Ölçüm Mesafesi	0.05 - 100 M
Ölçüm Hassasiyeti	± 2 mm
Ölçüm Birimleri	M / in / ft
Lazer Tipi	λ: 500-535nm≤1mw
Lazer Sınıfı	Class II
Max. Hafıza Kayıt	99 Kayıt
Sürekli Ölçüm	Evet
Alan Hesaplama	Evet
Hacim Hesaplama	Evet
Pisagor Ölçümü	Evet
Toplama/Çıkarma	Evet
Pil Tipi	3x1.5V AAA
Ölçüler	117x50x25 mm
Ağırlık	140 gr

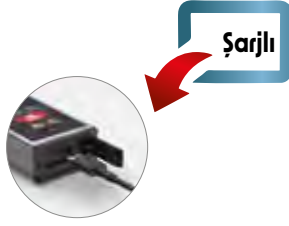

45 \$

## PL 50 R

**LAZER METRE / 50 m**  
**(Kırmızı Lazerli)**

Ölçüm Mesafesi	0.05 - 50 M
Ölçüm Hassasiyeti	± 2 mm
Ölçüm Birimleri	M / in / ft
Lazer Tipi	λ: 630-670nm≤1mw
Lazer Sınıfı	Class II
Sürekli Ölçüm	Evet
Alan Hesaplama	Evet
Hacim Hesaplama	Evet
Pisagor Ölçümü	Evet
Pil Tipi	2x1.5V AAA
Ölçüler	103x42x24 mm
Ağırlık	86 gr

65 \$

## PL 55 RS

**ŞARJLI LAZER METRE**  
**50 m (Kırmızı Lazerli)**

Ölçüm Mesafesi	0.05 - 50 M
Ölçüm Hassasiyeti	± 2 mm
Ölçüm Birimleri	M / in / ft
Lazer Tipi	λ: 630-670nm≤1mw
Lazer Sınıfı	Class II
Sürekli Ölçüm	Evet
Alan Hesaplama	Evet
Hacim Hesaplama	Evet
Pisagor Ölçümü	Evet
Batarya Tipi	3.7V 0.85A Li-ion
Ölçüler	100x34x18 mm
Ağırlık	67 gr

## ÇELİK ŞERİT METRELER

Kod	Ölçü	B. Fiyat
PR 5025	5x25 mm	3.20 \$



215 \$

## PL 360 LS

### LAZER 3 x 360° ŞAKÜL

Lazer Rengi	Yeşil
Lazer Sayısı	3x360°
Lazer Yönü	1 Yatay+2 Dikey
Lazer Tipi	520nm <1mw
Lazer Sınıfı	Class II
Hizalama Hassaslığı	± 1mm / 5m
Dengeleme Eğimi	± 3°
Max. Çalışma Mesafesi	40 m
Tripod Girişi	1/4"
Batarya (Li-ion)	3.7V 4.0Ah
Boyut	110x70x104mm
Ağırlık	420 gr

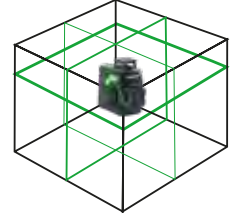

240 \$

## PL 460 LS

### LAZER 4 x 360° ŞAKÜL

Lazer Rengi	Yeşil
Lazer Sayısı	4x360°
Lazer Yönü	2 Yatay+2 Dikey
Lazer Tipi	520nm <1mw
Lazer Sınıfı	Class II
Hizalama Hassaslığı	± 1mm / 5m
Dengeleme Eğimi	± 3°
Max. Çalışma Mesafesi	40 m
Tripod Girişi	1/4"
Batarya (Li-ion)	3.7V 4.0Ah
Boyut	110x70x119mm
Ağırlık	440 gr

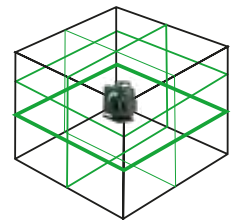

115 \$

## PL 260 LS

### LAZER ŞAKÜL DİSTOMAT (Yeşil Lazerli)

Lazer Rengi	Yeşil
Lazer Sayısı	2
Lazer Yönü	1 Yatay+1 Dikey
Lazer Tipi	520nm <1mw
Lazer Sınıfı	Class II
Hizalama Hassaslığı	± 1.5mm / 5m
Dengeleme Eğimi	± 4°
Max. Çalışma Mesafesi	25 m
Tripod Girişi	1/4"
Batarya (Li-ion)	6.0V 1.6Ah
Boyut	90x53x90mm
Ağırlık	280 gr



Yeşil Lazer

Şarjlı



Li-ion PİL

#### Aksesuarlı

- Miknatıslı Bağlantı Aparatı
- Plastik Taşıma Çantası



28 \$

## PL 15 T

### TRİPOD / SEHPA ALÜMİNYUM

Max. Yükseklik	150 cm
1. Kademe Yükseklik	54 cm
2. Kademe Yükseklik	85 cm
3. Kademe Yükseklik	117 cm
Ağırlık	850 gr

#### Adaptörler



#### Aksesuarlı

- 2 Adet Adaptör
- Bez Taşıma Çantası



Yüksek Performans  
**Ekonomik**  
Hızlı Servis



# Üstün Kalite

Ergonomik

Tasarım



53 \$

## PA 750-115

### AVUÇ TAŞLAMA MAKİNASI

Disk Çapı 115 mm  
Watt 750 W  
Devir Hızı 11.000 d/dk



 750 Watt

 115 mm

65 \$

## PA 9-115

### AVUÇ TAŞLAMA MAKİNASI

Disk Çapı 115 mm  
Watt 900 W  
Devir Hızı 11.000 d/dk



 900 Watt

 115 mm

70 \$

## PA 1115

### AVUÇ TAŞLAMA MAKİNASI

Disk Çapı 115 mm  
Watt 1050 W  
Devir Hızı 11.000 d/dk



 1050 Watt

 115 mm



Devir Ayarlı

 Hız Ayarlı  750 Watt

60 \$

## PA 715 E

### ELEKTRONİK HIZ AVUÇ TAŞLAMA

Disk Çapı 115 mm  
Watt 750 W  
Elektronik Hızı 0-11.000 d/dk



Devir Ayarlı

 Hız Ayarlı  900 Watt

72 \$

## PA 915 E

### ELEKTRONİK HIZ AVUÇ TAŞLAMA

Disk Çapı 115 mm  
Watt 900 W  
Elektronik Hızı 0-11.000 d/dk



Devir Ayarlı

 Hız Ayarlı  1200 Watt

90 \$

## PA 1225 E

### ELEKTRONİK HIZ AVUÇ TAŞLAMA

Disk Çapı 125 mm  
Watt 1200 W  
Elektronik Hızı 0-11.000 d/dk



140 \$

## PA 24-180

### JET TAŞLAMA MAKİNASI

Disk Çapı 180 mm  
Watt 2400 W  
Devir Hızı 8500 d/dk



 2400 Watt  180 mm



150 \$

## PA 24-230

### JET TAŞLAMA MAKİNASI

Disk Çapı 230 mm  
Watt 2400 W  
Devir Hızı 6500 d/dk



 2400 Watt  230 mm



160 \$



**PA 26-180**

**JET TAŞLAMA  
MAKİNASI**

Disk Çapı 180 mm  
Watt 2600 W  
Devir Hızı 8500 d/dk

 2600 Watt  180 mm



170 \$



**PA 26-230**

**JET TAŞLAMA  
MAKİNASI**

Disk Çapı 230 mm  
Watt 2600 W  
Devir Hızı 6500 d/dk

 2600 Watt  230 mm



70 \$

## PR 190 MK

### MINİ GRİNDER MİKRO KALIPÇI SETİ

Pens Çapı 3.2 mm  
Watt 170 W  
Elektronik Hızı 8000-35.000 d/dk



Devir Ayarlı

**Aksesuar Hediye**

- Plastik Çantalı Set
- 190 Parça Aksesuar



**Hız Ayarlı** **190 Parça Set**

70 \$

## PR 680 E

### KALIPÇI TAŞLAMA KISA TİP / Elektronik

Pens Çapı 6 mm  
Watt 600 W  
Elektronik Hızı 12.000-27.000 d/dk



Devir Ayarlı

**Kısa Tip** **Hız Ayarlı**

80 \$

## PR 690 E

### KALIPÇI TAŞLAMA UZUN TİP / Elektronik

Pens Çapı 6 mm  
Watt 600 W  
Elektronik Hızı 12.000-27.000 d/dk



Devir Ayarlı

**Uzun Tip** **Hız Ayarlı**



**Aksesuar Hediye**

- Plastik Disk
- Polisaj Keçesi

**Hız Ayarlı** **1200 Watt**

110 \$

**PL 180 E**

**POLİSAJ  
MAKİNASI**

Disk Çapı 180 mm  
Watt 1200 W  
Elektronik Hızı 600-3000 d/dk



**Aksesuar Hediye**

- Plastik Disk
- Polisaj Keçesi

**Hız Ayarlı** **125 mm**

115 \$

**PL 125 XP**

**ORBİTAL / EKSANTRİK  
POLİSAJ MAKİNASI**

Disk Çapı 125 mm  
Watt 710 W  
Elektronik Hızı 1500-5000 d/dk  
Orbital 8 mm



**Aksesuar Hediye**

- Plastik Disk
- Polisaj Keçesi
- 2 Adet Temizleme Fırçası

105 \$

**PL 178 E**

**OTO POLİSAJ & DÖŞEME  
TEMİZLEME MAKİNASI**

Disk Çapı 180 mm  
Watt 1010 W  
Elektronik Hızı 1000-4500 d/dk  
Mil Çapı M14



54 \$

## PR 450 RL

### DARBESİZ MATKAP 10 MM

Mandren Çapı	10 mm
Watt	400 W
Elektronik Hızı	0 - 2900 d/dk
Dönüş Yönü	Sağ - Sol
Mandren Tipi	Yarı Metal Supra



400 Watt 10 mm

Hız Ayarlı Sağ - Sol

70 \$

## PR 550 RL

### ŞANZIMANLI 10 MM DARBESİZ MATKAP

Mandren Çapı	10 mm
Watt	500 W
Elektronik Hızı	0 - 1560 d/dk
Dönüş Yönü	Sağ - Sol
Mandren Tipi	Yarı Metal Supra



500 Watt 10 mm

Hız Ayarlı Sağ - Sol

Şanzımanlı

2 Kat Güçlü

85 \$

## PR 770 RL

### ŞANZIMANLI 13 MM DARBESİZ MATKAP

Mandren Çapı	13 mm
Watt	750 W
Elektronik Hızı	0 - 1560 d/dk
Dönüş Yönü	Sağ - Sol
Mandren Tipi	Yarı Metal Supra



750 Watt 13 mm

Hız Ayarlı Sağ - Sol

Şanzımanlı

2 Kat Güçlü



-  650 Watt
-  13 mm
-  Hız Ayarlı
-  Sağ - Sol



60 \$

## PR 650 RL

### DARBELİ MATKAP 13 MM

Mandren Çapı	13 mm
Watt	650 W
Elektronik Hızı	0 - 2800 d/dk
Dönüş Yönü	Sağ - Sol
Mandren Tipi	Yarı Metal Supra



-  750 Watt
-  13 mm
-  Hız Ayarlı
-  Sağ - Sol



65 \$

## PR 750 RL

### DARBELİ MATKAP 13 MM

Mandren Çapı	13 mm
Watt	750 W
Elektronik Hızı	0 - 2800 d/dk
Dönüş Yönü	Sağ - Sol
Mandren Tipi	Yarı Metal Supra



-  Şanzımanlı
-  2 Kat Güçlü

-  1050 Watt
-  2 Vites
-  Hız Ayarlı
-  Sağ - Sol



115 \$

## PR 1150 RL

### DARBELİ MATKAP ŞANZIMANLI

Watt	1050 W
Delme Çapı	13-16 mm
Vites Adedi	2 Mekanik Vites
Elektronik Hızı	1.Vites 0-1100d/dk
Elektronik Hızı	2.Vites 0-2800d/dk
Dönüş Yönü	Sağ - Sol
Mandren Tipi	Metal Supra

135 \$

## PR 1650 MK

### KARIŞTIRICI MATKAP ŞANZIMANLI

Watt	1600 W
Vites Adedi	2 vites
Elek. Hızı 1.vites	180-400 d/dk
Elek. Hızı 2.vites	300-700 d/dk
Uç Mil Çapı	M 14
Karıştırıcı Uç Çapı	140 mm
Karıştırıcı Uç Boyu	600 mm

-  1600 Watt
-  2 Vites
-  Hız Ayarlı
-  Şanzımanlı



150 \$

## PR 1820 MK

### KARIŞTIRICI MATKAP ŞANZIMANLI

Watt	1800 W
Vites Adedi	2 vites
Elek. Hızı 1.vites	180-400 d/dk
Elek. Hızı 2.vites	300-700 d/dk
Uç Mil Çapı	M 14
Karıştırıcı Uç Çapı	140 mm
Karıştırıcı Uç Boyu	600 mm

-  1800 Watt
-  2 Vites
-  Hız Ayarlı
-  Şanzımanlı





Max. 300 N.m TORK

**Aksesuar Hediye**

İçindeki Lokmalar

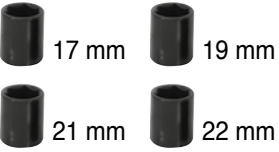

120 \$

**PR 1370 WS**

**ELEKTRİKLİ SOMUN  
SÖKME - SIKMA**

Soket Çapı	1/2" inch
Tork Gücü	300 N.m
Watt	710 W
Devir / Hız	2200 d/dk
Dönüş Yönü	Sağ - Sol
Net Ağırlık	3.2 Kg

 1/2" inch

 710 Watt

 300 N.m

 Çantalı Kit



Max. 450 N.m TORK

**Aksesuar Hediye**

İçindeki Lokmalar

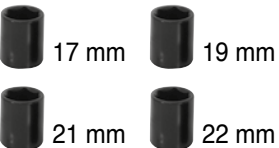

130 \$

**PR 1450 WS**

**ELEKTRİKLİ SOMUN  
SÖKME - SIKMA**

Soket Çapı	1/2" inch
Tork Gücü	450 N.m
Watt	1010 W
Devir / Hız	2200 d/dk
Dönüş Yönü	Sağ - Sol
Net Ağırlık	3.2 Kg

 1/2" inch

 1010 Watt

 450 N.m

 Çantalı Kit



105 \$

## PH 850 K

### PNOMATİK MATKAP DELİCİ - KIRICI

Watt	800 W
Delme Kapasite	26 mm
Elektronik Hızı	0 - 1200 d/dk
Darbe Sayısı	0 - 5300 d/dk
Vuruş Gücü	3.0 Joule
Dönüş Yönü	Sağ - Sol
Ağırlık	3.0 Kg



**P** 800 Watt

**P** 3.0 Joule

**P** Hız Ayarlı

**P** Çantalı Kit



**P** Aksesuar Hediye

- Plus Murç
- Plus Keski
- Plus Adaptör 1/2
- 13 mm 1/2 Mandren
- 2 ad. Plus delici uç

115 \$

## PH 900 VS

### PNOMATİK MATKAP DELİCİ - KIRICI

Watt	900 W
Delme Kapasite	28 mm
Elektronik Hızı	0 - 1250 d/dk
Darbe Sayısı	0 - 5000 d/dk
Vuruş Gücü	3.2 Joule
Dönüş Yönü	Sağ - Sol
Ağırlık	3.0 Kg



**P** 900 Watt

**P** 3.2 Joule

**P** Hız Ayarlı

**P** Çantalı Kit

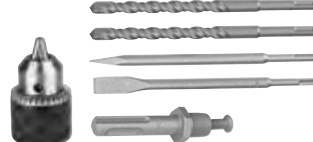

**P** Aksesuar Hediye

- Plus Murç
- Plus Keski
- Plus Adaptör 1/2
- 13 mm 1/2 Mandren
- 2 ad. Plus delici uç

310 \$

## PH 1350 K

**MAX KIRICI**  
**7.0 Kg**

Watt	1300 W
Vuruş Sayısı	2400 d/dk
Vuruş Gücü	20 Joule
Uç Tipi	Max
Ağırlık	7.0 Kg



20 Joule

### Aksesuar Hediye

- Max Kırıcı Murç
- Max Kırıcı Keski



 7.0 Kg

 1300 Watt

 20 Joule

 Çantalı Kit



330 \$

## PH 1250 HD

**MAX DELİCİ - KIRICI**  
**6.5 Kg**

Delme Kapasite	40 mm
Watt	1250 W
Delme Hızı	410 d/dk
Kırma Hızı	3600 d/dk
Vuruş Gücü	10 Joule
Ağırlık	6.5 Kg



10 Joule

### Aksesuar Hediye

- 3 Ad. Max Delici Uç  
16 mm-18 mm-22 mm
- 1 Ad. Max Kırıcı Murç
- 1 Ad. Max Kırıcı Keski



 6.5 Kg

 1250 Watt

 10 Joule

 Çantalı Kit



375 \$

## PH 1400 HD

**MAX DELİCİ - KIRICI**  
**8.5 Kg**

Delme Kapasite	50 mm
Watt	1400 W
Elektronik Hızı	280-540 d/dk
Vuruş Gücü	20 Joule
Uç Tipi	Max
Ağırlık	8.5 Kg

20 Joule



**P** 8.5 Kg

**P** 1400 Watt

**P** 20 Joule

**P** Çantalı Kit



**P** Aksesuar Hediyesi



- Max Delici Uç
- Max Kırıcı Murç
- Max Kırıcı Keski

425 \$

## PH 1515 HD

**MAX DELİCİ - KIRICI**  
**10 Kg**

Delme Kapasite	52 mm
Watt	1700 W
Elektronik Hızı	285-485 d/dk
Vuruş Gücü	22 Joule
Uç Tipi	Max
Ağırlık	10 Kg



22 Joule



**P** 10 Kg

**P** 1700 Watt

**P** 22 Joule

**P** Çantalı Kit



**P** Aksesuar Hediyesi



- Max Delici Uç
- Max Kırıcı Murç
- Max Kırıcı Keski

430 \$

## PH 1860 K

**MAX KIRICI**  
**11 Kg**

Watt	1800 W
Devir Hızı	Elektronik
Vuruş sayısı	900-1900 d/dk
Vuruş Gücü	25 Joule
Uç Tipi	Max
Ağırlık	11 Kg

25 Joule

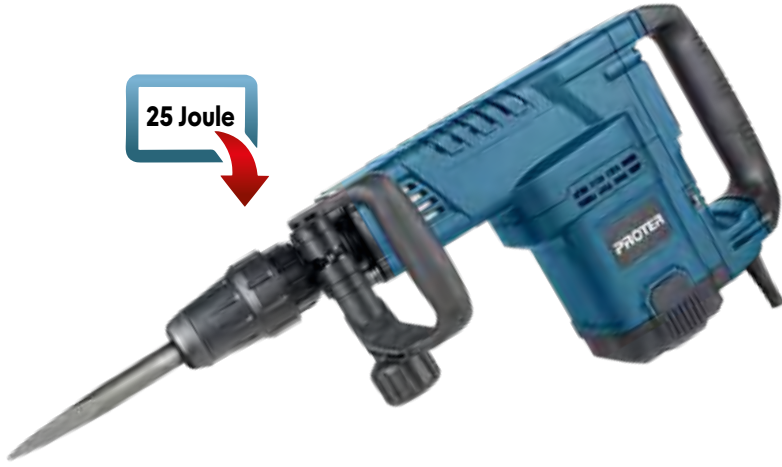

 11 Kg

 1800 Watt

 20 Joule

 Çantalı Kit



### Aksesuar Hediye

- Max Kırıcı Murç
- Max Kırıcı Keski



490 \$

## PH 1770 K

**HEX KIRICI**  
**17 Kg**

Watt	1700 W
Vuruş Sayısı	1450 d/dk
Vuruş Gücü	70 Joule
Uç Tipi	Hex
Ağırlık	17 Kg

70 Joule



 17 Kg

 1700 Watt

 70 Joule

 Çantalı Kit



### Aksesuar Hediye

- Hex Kırıcı Murç
- Hex Kırıcı Keski



Yüksek Performans  
**Ekonomik**  
Hızlı Servis



# Üstün Kalite

Ergonomik

Tasarım



160 \$

## PR 580 K

### KOYUN KIRKMA MAKİNASI

Watt	500 W
Elektronik Hızı	0 - 2800 d/dk
Kesim Genişlik	80 mm
Kesim Yükseklik	2-4 mm
Ağırlık	1.6 Kg



**P** 500 W **P** Elektronik Hız

**P** Beiyuan Marka Bıçak

110 \$

## PR 1001X MULTI

### ELEKTRİKLİ ÇOK AMAÇLI MULTİ MAKİNA

Watt	350 W
Max. Disk Çapı	80 mm
Salınım Açısı	4° (derece)
Elektronik Hızı	11000-18.500 d/dk



AKSESUARLARI İLE BİRLİKTE



**P** Elektronik Hız Ayarlı



**P** Çantalı Kit

#### **P** Aksesuar Özellikleri

- A1 Raspalama; Silikon ve halıflex yapıştırıcı artıklarını temizleme
- A2 Üçgen zımpara tabanı
- A3 Daldırma Kesim; Ahşap, plastik ve alüminyum
- A4 Duvar fayans derz dolgu temizleme
- A5 Raspalama; Boya, harç ve benzeri artıkları temizleme
- A6 Düz Kesim; Ahşap, plastik ve demir olmayan metaller için
- A7 Üçgen cırt kağıt zımpara (3 adet)

#### **P** Yedek Aksesuar Fiyatları

- A1 - Aksesuar 3.50 \$
- A2 - Aksesuar 5.50 \$
- A3 - Aksesuar 4.50 \$
- A4 - Aksesuar 8.50 \$
- A5 - Aksesuar 3.50 \$
- A6 - Aksesuar 9.00 \$
- A7 - Aksesuar 1.50 \$

40 \$



## PR 2360

### SICAK HAVA TABANCASI

Watt	2000 W
Fan Kapasite	300-500 Lt/dk
Fan Ayarı	3 Kademe
Sıcaklık Ayarı	60° - 600°



#### Aksesuar Hediye

- 4 Adet Fonksiyonel Başlık



 Isı Ayarlı  Fan Ayarlı



55 \$



## PR 2370 DX

### SICAK HAVA TABANCASI (Dijital Isı Göstergeli)

Watt	2000 W
Fan Kapasite	500 Lt / dk
Fan Ayarı	2 Kademe
Sıcaklık Ayarı	60° - 600°



Dijital Isı  
Göstergeli



#### Aksesuar Hediye

- 4 Adet Fonksiyonel Başlık



 Isı Ayarlı  Fan Ayarlı

 Dijital Isı Gösterge Paneli



85 \$

## PR 730 E

### TİLKİ KUYRUĞU TESTERE MAKİNASI

Watt	710 W
Elektronik Hızı	0-2800 d/dk
Kesim Kap. Ahşap	150 mm
Kesim Kap. Metal	115 mm



#### Aksesuar Hediye

- 2 Adet Testere Hediye
- Metal & Plastik Kesim Testeresi
- Paslanmaz Et - Kemik Testeresi



**710 Watt** **Hız Ayarlı**



105 \$

## PR 1130 E

### TİLKİ KUYRUĞU TESTERE MAKİNASI

Watt	1050 W
Elektronik Hızı	0-2500 d/dk
Kesim Kap. Ahşap	200 mm
Kesim Kap. Metal	150 mm



#### Aksesuar Hediye

- 2 Adet Testere Hediye
- Metal & Plastik Kesim Testeresi
- Paslanmaz Et - Kemik Testeresi



**1050 Watt** **Hız Ayarlı**





95 \$

## PC 185 T

### SUNTA KESME MAKİNASI

Testere Çapı	185 mm
Watt	1380 W
Devir Hızı	5300 d/dk
Kesim Derinliği (90°)	64 mm
Açılı Kes. Der. (45°)	45 mm

 185 mm

 1380 Watt



105 \$

## PC 190 A

### SUNTA KESME MAKİNASI

Testere Çapı	190 mm
Watt	1500 W
Devir Hızı	5300 d/dk
Kesim Derinliği (90°)	66 mm
Açılı Kes. Der. (45°)	43 mm

 190 mm

 1500 Watt



75 \$

## PR 420

**FORMİKA / LAMİNANT  
PVC TEMİZLEME**

Pens Çapı 6 mm  
Watt 350 W  
Devir Hızı 30.000 d/dk



**Aksesuar Hedyeli**

- Pvc Temizleme Bıçak Hedyeli

**6 mm 350 Watt**

125 \$

## PR 112 E

**EL FREZE MAKİNASI**

Pens Çapı 6 / 8 / 12 mm  
Watt 1200 W  
Devir Hızı 22.000 d/dk  
Derinlik Ayarı 0 - 50 mm



**12/8 mm Derinlik Ayarlı 1200 Watt**

175 \$

## PR 12 E

**EL FREZE MAKİNASI  
Ahşap & PVC**

Pens Çapı 8 / 12 mm  
Watt 1500 W  
Elektronik Hızı 8.000-25.000 d/dk  
Derinlik Ayarı 0 - 60 mm



**Aksesuar Hedyeli**

- 3 Adet Freze uç Hedyeli

**Derinlik Ayarlı Hız Ayarlı 1500 Watt**



98 \$

## PR 85

### EL PLANYA MAKİNASI

Watt	1100 W
Devir Hızı	16.000 d/dk
Lamba Derinliği	3 mm
Bıçak Boyu	82 mm



 1100 Watt  3mm Lamba

### Aksesuar Hedyeli

- 1 Adet Yedek Kayış



70 \$

## PD 610 E

### DEKUPAJ MAKİNASI

Watt	600 W
Elektronik Hızı	0-2900 d/dk
Maximum Kesim	65 mm
Pandül Hareketi	4 Kademe



 Hız Ayarlı  Pandüllü  Kolay Uç Değişim Sistemi



105 \$

## PD 750 E

### ŞANZIMANLI DEKUPAJ MAKİNASI

Watt	750 W
Elektronik Hızı	800-3000 d/dk
Maximum Kesim	100 mm
Pandül Hareketi	4 Kademe



Şanzımanlı



 Hız Ayarlı  Pandüllü  Kolay Uç Değişim Sistemi

250 \$

## PR 315 E

### ORBİTAL ZIMPARA MAKİNASI

Taban Ölçüsü	150 mm
Watt	350 W
Elektronik Hızı	4000-10000 d/dk
Orbital Çapı	5.0 mm
Ağırlık	1.5 Kg



Kömürsüz

Hız Ayarlı

150 mm Orbital / Eksantrik

85 \$

## PR 350 E

### TİTREŞİM ZIMPARA MAKİNASI

Watt	300 W
Elektronik Hızı	6000-12000 d/dk
Taban Ölçüsü	115x230 mm



300 Watt Hız Ayarlı

98 \$

## PR 470 EX

### EKSANTRİK ZIMPARA MAKİNASI

Taban Ölçüsü	125 / 150 mm
Watt	450 W
Elektronik Hızı	4000-13000 d/dk



125 mm 150 mm Çift Tabanlı Hız Ayarlı



Aksesuar Hediye

- 1 Adet 125 mm Taban
- 1 Adet 150 mm Taban



65 \$

**PR 125**

**125 MM  
ZIMPARA TAŞ MOTORU**

Taş Çapı 125 mm  
Watt 170 W  
Voltaj 220 V



75 \$

**PR 150**

**150 MM  
ZIMPARA TAŞ MOTORU**

Taş Çapı 150 mm  
Watt 250 W  
Voltaj 220 V



95 \$

**PR 175**

**175 MM  
ZIMPARA TAŞ MOTORU**

Taş Çapı 175 mm  
Watt 350 W  
Voltaj 220 V



105 \$

**PR 200**

**200 MM  
ZIMPARA TAŞ MOTORU**

Taş Çapı 200 mm  
Watt 350 W  
Voltaj 220 V



75 \$

## PR 80/16 K

### HAVALI DÖŞEME TABANCASI

Max. Tel Boyu	16 mm
Min. Tel Boyu	6 mm
Tel Genişlik	12.8 mm
Tel Kalınlık	0.65 x 0.95 mm



#### Çantalı Kit

- Taşıma Çantası
- Yağdanlık Seti
- Allen Anahtarı

6-16 mm

Professional

80 \$

## PR 80/16 D

### HAVALI DÖŞEME TABANCASI

Max. Tel Boyu	16 mm
Min. Tel Boyu	6 mm
Tel Genişlik	12.8 mm
Tel Kalınlık	0.70 x 0.90 mm



#### Çantalı Kit

- Taşıma Çantası
- Yağdanlık Seti
- Allen Anahtarı

6-16 mm

Professional

155 \$

## PR 9240 K

### HAVALI KASA ÇAKMA ZIMBA TABANCASI

Max. Tel Boyu	40 mm
Min. Tel Boyu	16 mm
Tel Genişlik	8.6 mm
Tel Kalınlık	1.0 x 1.25 mm



#### Çantalı Kit

- Taşıma Çantası
- Yağdanlık Seti
- Allen Anahtarı

16-40 mm

Professional



85 \$

## PR 32 K

### HAVALI ÇİVİ ÇAKMA TABANCASI

Max. Çivi Boyu	32 mm
Min. Çivi Boyu	10 mm
Çivi Kalınlık	1.0 x 1.25 mm



 10-32 mm  Professional

#### Çantalı Kit

- Taşıma Çantası
- Yağdanlık Seti
- Allen Anahtarı



110 \$

## PR 52 K

### HAVALI ÇİVİ ÇAKMA TABANCASI

Max. Çivi Boyu	50 mm
Min. Çivi Boyu	20 mm
Çivi Kalınlık	1.0 x 1.25 mm



 20-50 mm  Professional

#### Çantalı Kit

- Taşıma Çantası
- Yağdanlık Seti
- Allen Anahtarı

#### Zimba & Çivi



125 \$

## PR 9040 K

### HAVALI ZIMBA VE ÇİVİ ÇAKMA TABANCASI

Tel Boyu	16-40 mm
Tel Genişlik	5.7 mm
Çivi Boyu	20-50 mm
Çivi Kalınlık	1.0 x 1.25 mm



 20-50 mm  Professional

#### Çantalı Kit

- Taşıma Çantası
- Yağdanlık Seti
- Allen Anahtarı

Yüksek Performans  
**Ekonomik**  
Hızlı Servis



# Üstün Kalite

Ergonomik

Tasarım



275 \$

## PR 835 E

### DUVAR & ALÇIPAN ZIMPARA MAKİNASI

Watt	850 W
Elektronik Hızı	800-1700 d/dk
Disk Çapı	225 mm
Makina Boyu	1200-1900 mm
Hortum Boyu	2 mt.
Net Ağırlık	4.5 kg



#### Aksesuar Hediye

- Taşıma Çantası
- 6 Adet Kağıt Zımpara
- Toz Emme Hortumu
- Yıldız Tornavida
- Allen Anahtarı
- Bağlantı Adaptörü
- Toz Emme Torbası

Çantalı Kit

Uzatmalı Sap

Devir Ayarlı

#### Yedek Cırt Zımpara Fiyatları

- 120 Kum x 225 mm **0,85 \$**
- 150 Kum x 225 mm **0,85 \$**
- 180 Kum x 225 mm **0,85 \$**

195 \$

## PR 1540 CL

### KANAL AÇMA MAKİNASI

Bıçak Çapı	125 mm
Watt	1500 W
Devir Hızı	8500 d/dk
Kesim Derinlik	5 - 29 mm
Kesim Genişlik	8 - 30 mm



1500 Watt Derinlik Ayarlı

125 mm Genişlik Ayarlı



440 \$

## PR 1245 WK

### KANAL KAZIMA MAKİNASI

Watt	1100 W
Devir Hızı	2000 d/dk
Kesim Derinlik	30 mm
Kesim Genişlik	35 mm



 PR 45-25 B Yedek Bıçak 25 mm - 50 \$

 PR 45-35 B Yedek Bıçak 35 mm - 90 \$



 **Aksesuar Hediye**

- PR 45-35 B  
1 Adet 35 mm bıçak



 1100 Watt  Ø30x35mm

 Dm. Ayarlı  Çantalı Kit



520 \$

## PR 1090 WK

### KANAL KAZIMA MAKİNASI

Watt	2000 W
Devir Hızı	2200 d/dk
Kesim Derinlik	35 mm
Kesim Genişlik	35 mm



 PR 90-25 B Yedek Bıçak 25 mm - 90 \$

 PR 90-35 B Yedek Bıçak 35 mm - 105 \$



 **Aksesuar Hediye**

- PR 90-35 B  
1 Adet 35 mm bıçak



 2000 Watt  Ø35x35 mm

 Çantalı Kit

190 \$

## PR 4300 TP

### BETON VİBRATÖR MOTORU

Hortum Fiyata Dahil Değildir!

Watt 2300 W  
Güç (HP) 3 HP  
Devir Hızı 4.000 d/dk



Ⓟ 2300 Watt Ⓟ 4.000 d/dk

Ⓟ Omuz Taşıma Askılı

95 \$

## PR 438 T

### VİBRATÖR HORTUMU

Boy 4 m  
Şişe Çapı 38 mm



Ⓟ 4x38 mm

105 \$

## PR 445 T

### VİBRATÖR HORTUMU

Boy 4 m  
Şişe Çapı 45 mm



Ⓟ 4x45 mm

Vibratör hortumları garanti kapsamı dışındadır!

130 \$

## PR 545 T

### VİBRATÖR HORTUMU

Boy 5 m  
Şişe Çapı 45 mm



Ⓟ 5x45 mm

140 \$

## PR 645 T

### VİBRATÖR HORTUMU

Boy 6 m  
Şişe Çapı 45 mm



Ⓟ 6x45 mm



340 \$

### PR 5300 HF

#### BETON VİBRATÖR MOTORU (Yüksek Frekans)

Hortum Fiyata Dahil Değildir!

Watt 2300 W  
Güç (HP) 3 HP  
Devir Hızı 18.000 d/dk



 18.000 d/dk  Omuz Taşıma Askılı



150 \$

### PR 1445 F

#### VİBRATÖR HORTUMU (Yüksek Frekans)

Boy 4 m  
Şişe Çapı 45 mm



 Yüksek Frekans  4x45 mm

Vibratör hortumları garanti kapsamı dışındadır!



160 \$

### PR 1545 F

#### VİBRATÖR HORTUMU (Yüksek Frekans)

Boy 5 m  
Şişe Çapı 45 mm



 Yüksek Frekans  5x45 mm

340 \$

## PR 210 Plus

### GÖNYE KESME MAKİNASI (Ahşap & Alüminyum)

Testere Çapı	210 mm
Watt	1500 W
Devir Hızı	4500 d/dk
Kesim Derinliği (90°)	55 mm
Kesim Genişliği (90°)	120 mm
Üstten Kesim Derinlik	40 mm
Açılı Kesim	45°
Testere Diş Sayısı	64 diş
Ağırlık	12 Kg

 210 mm  Üstten Kesim

 Yatırlı  Açılı Kesim

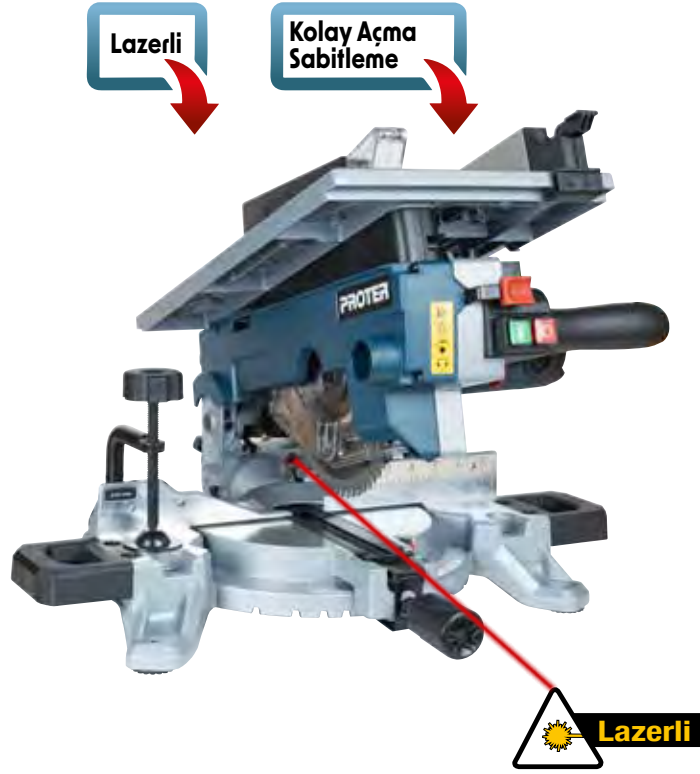

490 \$

## PR 255 Plus

### GÖNYE KESME MAKİNASI (Ahşap & Alüminyum)

Testere Çapı	250 mm
Watt	1800 W
Devir Hızı	4800 d/dk
Kesim Derinliği (90°)	75 mm
Kesim Genişliği (90°)	120 mm
Üstten Kesim Derinlik	55 mm
Açılı Kesim	45°
Testere Diş Sayısı	80 diş
Ağırlık	17 Kg

 250 mm  Üstten Kesim

 Yatırlı  Açılı Kesim

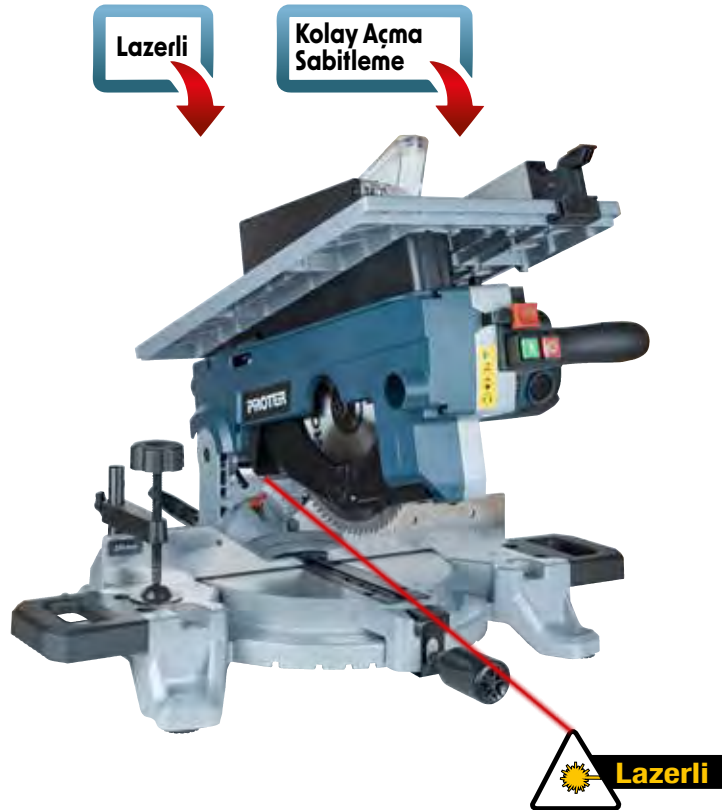

550 \$

## PR 305

### GÖNYE KESME MAKİNASI (Ahşap & Alüminyum)

Testere Çapı	300 mm
Watt	2000 W
Devir Hızı	4200 d/dk
Kesim Derinliği (90°)	85 mm
Kesim Genişliği (90°)	170 mm
Üstten Kesim Derinlik	50 mm
Açılı Kesim	45°
Testere Diş Sayısı	100 diş
Ağırlık	20.5 Kg



 300 mm  Üstten Ksm.

 Yatarlı  Açılı Kesim

570 \$

## PR 305 Radial

### GÖNYE KESME MAKİNASI (Sağ-Sol Yatarlı Açılı Kesim)

Testere Çapı	300 mm
Watt	2000 W
Devir Hızı	4500 d/dk
Max. Kesme 0°/0°	104x340 mm
Max. Kesme 0°/45°	40x340 mm
Max. Kesme 45°/0°	104x240 mm
Max. Kesme 45°/45°	40x240 mm
Testere Diş Sayısı	100 diş
Ağırlık	23 Kg



 300 mm  Lazerli

 Kızaklı  Yatarlı

**230 \$**

## PR 2455

### TAŞLI METAL KESME MAKİNASI

Taş Çapı	355 mm
Watt	2400 W
Devir Hızı	3.800 d/dk
Ağırlık	17.5 kg



**P** 355 mm **P** 2400 W

**240 \$**

## PR 355 K

### KAYIŞLI TAŞLI METAL KESME MAKİNASI

Taş Çapı	355 mm
Watt	2300 W
Devir Hızı	3.800 d/dk
Ağırlık	16.2 kg

**Kayışlı  
Motor**



**P** 355 mm **P** Kayışlı Motor



Sehpalı

**360 \$**

## PR 250 TM

### SEHPALI TEZGAH TESTERE MAKİNASI

Testere Çapı	250 mm
Watt	2000 W
Devir Hızı	5000 d/dk
Kesim Derinliği (90°)	85 mm
Kesim Genişliği (45°)	65 mm
Açılı Kesim	45°
Testere Diş Sayısı	60 diş
Tabla Ölçüsü	58x90 cm
Ağırlık	22 Kg

 250 mm  Üstten Kesim

 Yatarlı  Açılı Kesim



**195 \$**

## PR 13

### SÜTUNLU MATKAP TEZGAHI 13 MM

Mandren Çapı	13 mm
Watt	350 W
Voltaj	220 V
Vites Sayısı	5 vites
Devir Hızı	620-2620 d/dk
Mil Çapı	B16
Mil Hareketi	50 mm
Döner Tabla (mm)	160 x 160
Ağırlık	16 Kg

 13 mm  350 Watt

 5 Vites  580 mm boy

**350 \$**

## PR 16 S

### SÜTUNLU MATKAP TEZGAHI 16 MM

Mandren Çapı	16 mm
Watt	550 W
Voltaj	220 V
Vites Sayısı	5 vites
Devir Hızı	620 - 2620 d/dk
Mil Çapı	B16
Mil Hareketi	65 mm
Döner Tabla	200 x 200 mm
Ağırlık	25 Kg



 16 mm  550 Watt

 5 Vites  840 mm boy

**550 \$**

## PR 16 U

### SÜTUNLU MATKAP TEZGAHI 16 MM UZUN BOY

Mandren Çapı	16 mm
Watt	550 W
Voltaj	220 V
Vites Sayısı	16 vites
Devir Hızı	180 - 2770 d/dk
Mil Çapı	B16
Mil Hareketi	80 mm
Döner Tabla	250 x 250 mm
Yükseklik	1580 mm
Ağırlık	52 Kg



 16 mm  Uzun Boy

 550 Watt  16 Vites



**725 \$**

## PR 25

### SÜTUNLU MATKAP TEZGAHI 25 MM

Delme Çapı	25 mm
Watt	750 W
Voltaj	220 V
Vites Sayısı	12 vites
Devir Hızı	280 - 2380 d/dk
Mil Çapı	MT 3
Mil Hareketi	85 mm
Döner Tabla	290 x 290 mm
Yükseklik	1600 mm
Ağırlık	68 Kg

 25 mm

 Uzun Boy

 750 Watt

 12 Vites



**1200 \$**

## PR 35

### SÜTUNLU MATKAP TEZGAHI 32 MM / TRİFAZE

Delme Çapı	32 mm
Watt	1500 W/1.5 Kw
Voltaj	380 V / Trifaze
Vites Sayısı	12
Devir Hızı	150 - 2450 d/dk
Mil Çapı	MT 4
Mil Hareketi	120 mm
Döner Tabla	360 x 360 mm
Yükseklik	1710 mm
Ağırlık	110 Kg

 32 mm

 Uzun Boy

 1500 Watt

 12 Vites

Yüksek Performans  
**Ekonomik**  
Hızlı Servis



# Üstün Kalite

Ergonomik

Tasarım



340 \$

## PRO 200

### İNVERTER KAYNAK MAKİNESİ

Elektrod Çapı	1.5 - 4.0 mm
Voltaj	220 V
Frekans	50 Hz
Giriş Gücü	6.5 KW
Amper Aralığı	10 - 200 A
Çalışma Verimi	20%200 A
Çalışma Verimi	60%115 A
Çalışma Verimi	100%90 A
Boşta Çalışma Volt.	70 V
Koruma Sınıfı	IP 21 S
İzolasyon Sınıfı	H
Boyutlar (mm)	250x120x180
Net Ağırlık	3.2 Kg



☐ Sürekli Yakma 3.25 mm

☐ Max. Yakma 4.0 mm

☐ Fan Soğutmalı

☐ Pratik Kullanım



50 \$

## ARGON TİG KAYNAK MASKESİ

Açma Kapama	Tam Otomatik
Güç Kaynağı	Güneş Enerjisi (Pil Gerektirmez)
Koruyucu Plaka Ölçüsü	110x90 mm
Görüş Alanı	96 x 39 mm
UV ve IR Koruması	DIN 16 Kadar Sürekli
Kararma Süresi	1/30000 ms
Aydınlanma Süresi	0.25 - 0.8 s Ayarlanabilir
Kararma Kontrolü	DIN 4'e göre DIN 9~13 değişebilir
Çalışma Sıcaklığı	-5° +55°
Saklama Sıcaklığı	-20° +70°
Ağırlık	480 gr



☐ Colomatic

☐ Güneş Enerjili

☐ Automatic

☐ Işığa Duyarlı





Kolay Zincir Ayarlama

 40 cm Pala  2400 Watt

140 \$

## PGS 2400

### ELEKTRİKLİ ZİNCİRLİ AĞAÇ KESİM MOTORU

Pala boyu	40 cm
Watt	2400 W
Zincir Yağlama	Otomatik
Pala Cinsi	Proter
Zincir Cinsi	Proter



euro5 motor

 30 cm  1.2 Hp  Professional  Kolay Çalıştırma



160 \$

## PGS 4250 EU

### BENZİNLİ ZİNCİRLİ AĞAÇ KESİM MOTORU

Pala boyu	30 cm
Güç ( hp )	1.2 hp
Silindir Hacmi	25.4 cc
Yakıt Tank Kap.	400 ml
Benzin-Yağ Karışımı	1/25 orantı
Zincir Yağlama	Otomatik
Ağırlık	4 Kg

Aksesuar Hediyeli

- Buji Anahtarı
- Allen Anahtarı
- Tornavida
- Benzin Yağ Karışım Bidonu



euro5 motor

 52 cm  3 Hp  Kolay Çalıştırma  Professional



175 \$

## PGS 5250 EU

### BENZİNLİ ZİNCİRLİ AĞAÇ KESİM MOTORU

Pala boyu	52 cm
Güç ( hp )	3 hp
Silindir Hacmi	52 cc
Yakıt Tank Kap.	550 ml
Benzin-Yağ Karışımı	1/25 orantı
Zincir Yağlama	Otomatik
Ağırlık	6.5 Kg

175 \$

## PGS 452 T

### BENZİNLİ MİSİNALI YAN TIRPAN

Silindir Hacmi	52 cc
Motor Tipi	2 Zamanlı
Güç ( hp )	2.0 hp
Yakıt Tank Kapasite	1200 ml
Benzin -Yağ Karışımı	25/1 orantı
Ağırlık	7.2 Kg



**P** 52 cc **P** Kolay Çalıştırma

**P** 2.0 Hp **P** Professional



215 \$

## PGS 452 ST

### BENZİNLİ MİSİNALI SIRT TIRPAN

Silindir Hacmi	52 cc
Motor Tipi	2 Zamanlı
Güç ( hp )	2.0 hp
Yakıt Tank Kapasite	1200 ml
Benzin -Yağ Karışımı	25/1 orantı
Ağırlık	10.4 Kg



**P** 52 cc **P** Kolay Çalıştırma

**P** 2.0 Hp **P** Professional





145 \$

**PR 1330 E**  
**ELEKTRİKLİ**  
**ÇİM BİÇME MAKİNESİ**

Motor Gücü	1200 W
Voltaj	220 V
Devir Hızı	3500 d/dk
Kesim Kapasite	32 cm
Kesim Yüksek. Ayarı	3 kademe
Kesim Yüksekliği	20/35/50mm
Çim Toplama Kapst.	35 Lt
Tekerlek Boyutları	120x140mm
Ağırlık	9 Kg

 32 cm  3 Kademe



595 \$

**PGS 685 SL**  
**BENZİNLİ (Şanzımanlı)**  
**ÇİM BİÇME MAKİNESİ**

Motor Gücü	6.0 Hp
Şase Tipi	Çelik
Çalışma Tipi	Şanzımanlı
Yakıt Tipi	Benzin
Motor	N675
Motor Hacmi	196 cc
Kesme Genişliği	501 mm
Yükseklik Ayarı	7/25-75 mm
Çim Toplama Kapasite	60 Lt
Yakıt Deposu (Lt)	0.80 Lt
Yağ Kapasitesi (Lt)	0.60 Lt
Tekerlek Boyutları	175x200 mm
Ağırlık	37 Kg

 6.0 Hp  196 cc

Motor Tipi: Tek Silindirli  
4 Zamanlı Hava Soğutmalı  
OHV Benzinli Motor

Yüksek Performans  
**Ekonomik**  
Hızlı Servis



# Üstün Kalite

Ergonomik

Tasarım



## ZİNCİRLİ CERASKALLAR & HUBZUGLAR



Ürün Kodu	Kaldırma Kapasitesi	Zincir Uzunluk	Koli Adet	Birim Fiyat
PL 3x10	1.0 Ton	3 metre	4	78.00 \$
PL 3x20	2.0 Ton	3 metre	3	98.00 \$
PL 3x30	3.0 Ton	3 metre	2	145.00 \$
PL 5x10	1.0 Ton	5 metre	4	95.00 \$
PL 5x20	2.0 Ton	5 metre	3	125.00 \$
PL 5x30	3.0 Ton	5 metre	2	185.00 \$
PL 5x50	5.0 Ton	5 metre	1	290.00 \$

### ZİNCİRLİ HUBZUG PL 15x15

155 \$

1.5 Ton

1.5 Metre

Uzun Kollu

Professional



3 Koli Adet

### ZİNCİRLİ HUBZUG PL 15x30

230 \$

3.0 Ton

1.5 Metre

Uzun Kollu

Professional



2 Koli Adet



Bakır Sargılı

190 \$

**PR 2500**

**ELEKTRİKLİ  
MİNİ VİNÇ / 250-500 KG**

Tek Halat 20 m. : 250 Kg Kaldırma  
Çift Halat 10 m. : 500 Kg Kaldırma  
Ağırlık: 14 Kg



 20 mt Halat  1020 W

 250 - 500 Kg Kapasite



Bakır Sargılı

220 \$

**PR 4800**

**ELEKTRİKLİ  
MİNİ VİNÇ / 400-800 KG**

Tek Halat 20 m. : 400 Kg Kaldırma  
Çift Halat 10 m. : 800 Kg Kaldırma  
Ağırlık: 17 Kg



 20 mt Halat  1300 W

 400 - 800 Kg Kapasite



Bakır Sargılı

320 \$

**PR 6200**

**ELEKTRİKLİ  
MİNİ VİNÇ / 600-1200 KG**

Tek Halat 20 m.:600 Kg Kaldırma  
Çift Halat 10 m.:1200 Kg Kaldırma  
Ağırlık: 29 Kg



 20 mt Halat  1800 W

 600 - 1200 Kg Kapasite

210 \$

## PR 2550 CW

**BASINÇLI OTO YIKAMA  
MAKİNASI / Makaralı**

Watt	2100 W
Max. Bar	160 Bar
Su Sevk Miktarı	5.6 Lt d/dk
Ağırlık	10.7 Kg

Makaralı

Köpüklü  
Yıkama



**P** 160 Bar **P** 2100 W

**P** Su Giriş Filtreli



340 \$

## PR 2700 CW

**BASINÇLI OTO YIKAMA  
MAKİNASI / Makaralı**

Watt	2500 W
Max. Bar	180 Bar
Su Sevk Miktarı	7 Lt d/dk
Ağırlık	19.7 Kg



Makaralı

Induction  
Motor

Köpüklü  
Yıkama



**P** 2500 Watt **P** 180 Bar

**P** Su Giriş Filtreli





230 \$

### PR 303 DP

#### 3 TON (Düşük Profil) ARABALI GARAJ KRIKOSU

Max. Kaldırma Yükseklik	500 mm
Min. Kaldırma Yükseklik	75 mm
Uzunluk	700 mm
Ağırlık	32 Kg

 3 Ton

 Düşük Profil



240 \$

### PR 9150 DK

#### HİDROLİK DİKEY ŞANZİMAN KRIKOSU

Max. Kapasite	500 Kg
Max.Yükseklik	1950 mm
Min.Yükseklik	1150 mm
Ağırlık	30 Kg

 500 Kg

 Hidrolik

390 \$

## PR 9210 W

### 1 TON KATLANIR HİDROLİK VİNC

Kaldırma Gücü	1 Ton
Kaldırma Aralığı	25-2000 mm
Ayak Uzunluğu	1500 mm
Ayak Genişliği	1000 mm
Yükseklik	1450 mm
Ağırlık	68 Kg



**P** 1 Ton

**P** Katlanır

**P** Hidrolik

**P** 3 Ayaklı

430 \$

## PR 9220 W2

### ÇİFT PİSTON 2 TON KATLANIR HİDROLİK VİNC

Kaldırma Gücü	2 Ton
Kaldırma Aralığı	25-2300 mm
Ayak Uzunluğu	1660 mm
Ayak Genişliği	1010 mm
Yükseklik	1550 mm
Ağırlık	82 Kg

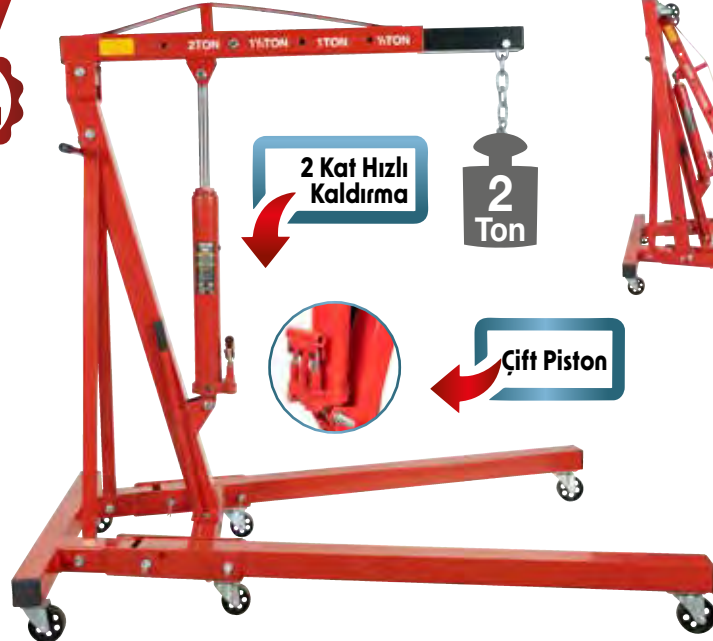

**P** 2 Ton

**P** Katlanır

**P** Çift Piston

**P** Hidrolik

**P** 3 Ayaklı

**P** Hızlı Kaldırma

215 \$



## PR 1204 T

### 4 TON HİDROLİK OTO DOĞRULTMA

Kapasite	4 Ton
Çalışma Mesafesi	120 mm
Min. Yükseklik	270 mm
Ağırlık	17 Kg

4 TON

Taşıma Çantalı



285 \$



## PR 1210 T

### 10 TON HİDROLİK OTO DOĞRULTMA

Kapasite	10 Ton
Çalışma Mesafesi	130 mm
Min. Yükseklik	367 mm
Ağırlık	31 Kg

10 TON

Tekerlekli Taşıma Çantalı



36 \$

## PL 122 S

### ŞARJLI EL FENERİ

Volt	3.7 V
Amper	2.2 Ah
Aydınlatma Gücü	240 Lümen
Aydınlatma Tipi	3 Farklı Aydınlatma
Çalışma Süresi	3-10 Saat
Şarj Süresi	3 Saat
Ağırlık	Ağırlık 195 gr
Ölçüler	163x52x32 mm

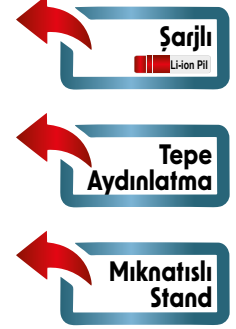

**P** 3 W Led

**P** Type-C Giriş

**P** SMD + COB Led

**P** Sağlam Gövde



43 \$

## PL 124 S

### ŞARJLI EL FENERİ

Volt	3.7 V
Amper	4.4 Ah
Aydınlatma Gücü	420 Lümen
Aydınlatma Tipi	3 Farklı Aydınlatma
Çalışma Süresi	3-10 Saat
Şarj Süresi	4 Saat
Ağırlık	260 gr
Ölçüler	190x59x34 mm

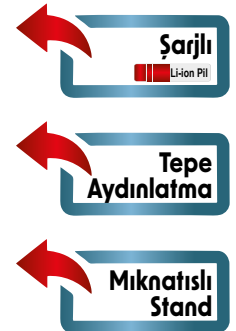

**P** 5 W Led

**P** Type-C Giriş

**P** SMD + COB Led

**P** Sağlam Gövde



30 \$

Dijital  
Gösterge



**PR 247 DC**

**LASTİK ŞİŞİRME  
MİNİ KOMPRESÖR**

Max. Basınç 150 PSI

Güç / Volt DC 12 V

Hava Debisi 35 lt / dk

Ağırlık 0.9 Kg



 Güçlü Motor

 Flaşörlü

 Metal Gövde

 Lambalı

 3 Adet Şişirme Adaptörü

 Çakmak Soketi Girişli

 Akü Bağlantı Maşası



48 \$

Çift  
Pistonlu



**PR 265 P2**

**LASTİK ŞİŞİRME  
(Çift Pistonlu)**

Max. Basınç 150 PSI

Güç / Volt DC 12 V

Hava Debisi 55 lt / dk

Ağırlık 2 Kg



 2 Pistonlu

 Led Işıklı

 Güçlü Motor

 Metal Gövde

 3 Adet Şişirme Adaptörü

 Çakmak Soketi Girişli

 Akü Bağlantı Maşası



40 \$

## SET - 5

5 PARÇALI  
KOMPRESÖR SETİ

- Boya Tabancası
- Lastik Şişirme Tabancası
- Spiral Hortum
- Kısa Hava Tabancası
- Mazot Tabancası



45 \$

## FR 300

FASARİT TABANCASI

- 6000 ml Plastik Depo
- 4-6-8 mm Meme Takımlı



12 \$

## DO-10

MAZOT TABANCASI

- 600 ml Metal Depo



12 \$

**TG-4**  
LASTİK ŞİŞİRME TABANCASI



35 \$

**TG-104 DX**  
DİJİTAL LASTİK ŞİŞİRME TABANCASI



Ⓟ PSI, Bar, Kg/cm<sup>2</sup>, Kpa

Ⓟ 0-255 PSI Ⓟ 50cm Hortum

5 \$

**DG-10B-1**  
KISA METAL HAVA TABANCASI



Ⓟ 100 mm / Metal Gövde

30 \$

**PS3**  
KUMLAMA TABANCASI



Ⓟ 1.5 m. Hortum Boyu



6 \$

**DG-10B-3**  
UZUN METAL HAVA TABANCASI



Ⓟ 300 mm / Metal Gövde

32 \$

## G-70

ALTAN DEPO  
BOYA TABANCASI

1000 ml Alü. Metal Depo



- 1.8 mm Meme
- 2.2 mm Meme
- 2.0 mm Meme
- 2.5 mm Meme



30 \$

## E-70

BOYA VE POLYESTER  
TABANCASI

600 ml Alü. Metal Depo



- 2.5 mm Meme
- 3.0 mm Meme



50 \$

## 4001 S

ALTAN DEPO  
BOYA TABANCASI

1000 ml Alü. Metal Depo



- 1.7 mm Meme
- 2.5 mm Meme
- 2.0 mm Meme



55 \$

## AB-17S

ALTAN DEPO  
BOYA TABANCASI

1000 ml Alü. Metal Depo



- 1.4 mm Meme
- 2.0 mm Meme
- 1.7 mm Meme



35 \$

**HK 827**  
**ÜSTTEN DEPO**  
**BOYA TABANCASI**

 600 ml Plastik Depo



- 3 Ayarlı
- 1.3 mm Meme
- 1.4 mm Meme
- 1.7 mm Meme



30 \$

**H 2000**  
**GÖLGE / SİS**  
**BOYA TABANCASI**

 125 ml Plastik Depo



- 3 Ayarlı
- 0.5 mm Meme
- 0.8 mm Meme
- 1.0 mm Meme



27 \$

**CV**  
**GÖLGE / SİS**  
**BOYA TABANCASI**

 125 ml Metal Depo



- 3 Ayarlı
- 0.5 Meme



47 \$

**AB-17 G**  
**ÜSTTEN DEPO**  
**BOYA TABANCASI**

 600 ml Plastik Depo



- 3 Ayarlı
- 1.3 mm Meme
- 1.4 mm Meme



Yüksek Performans  
**Ekonomik**  
Hızlı Servis

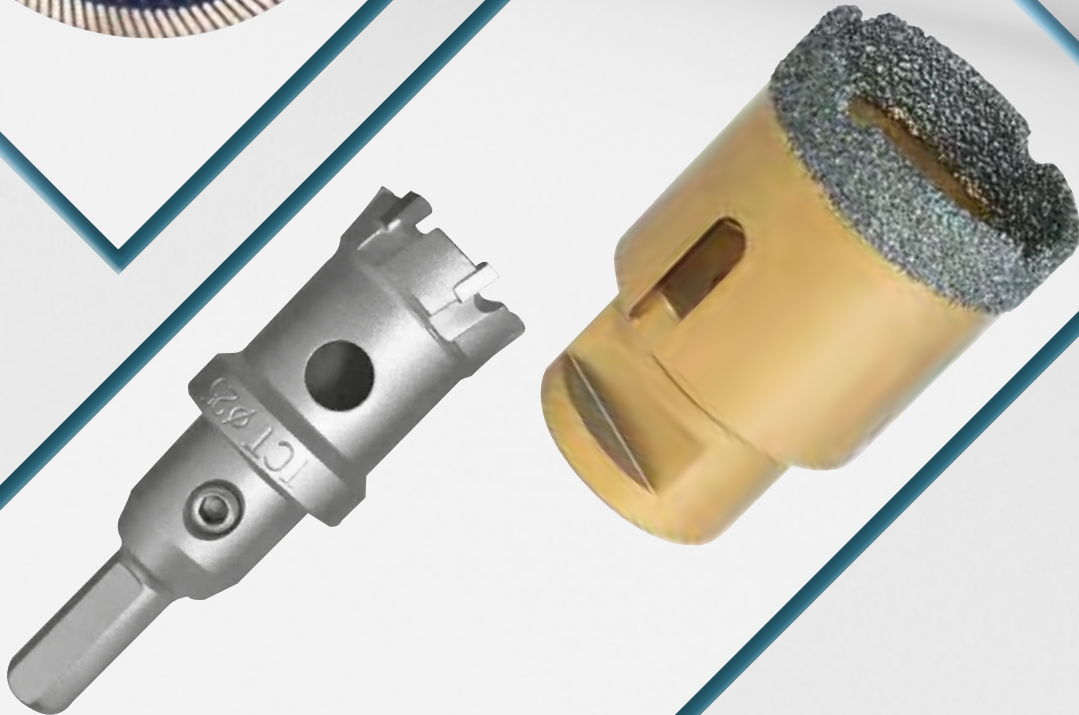
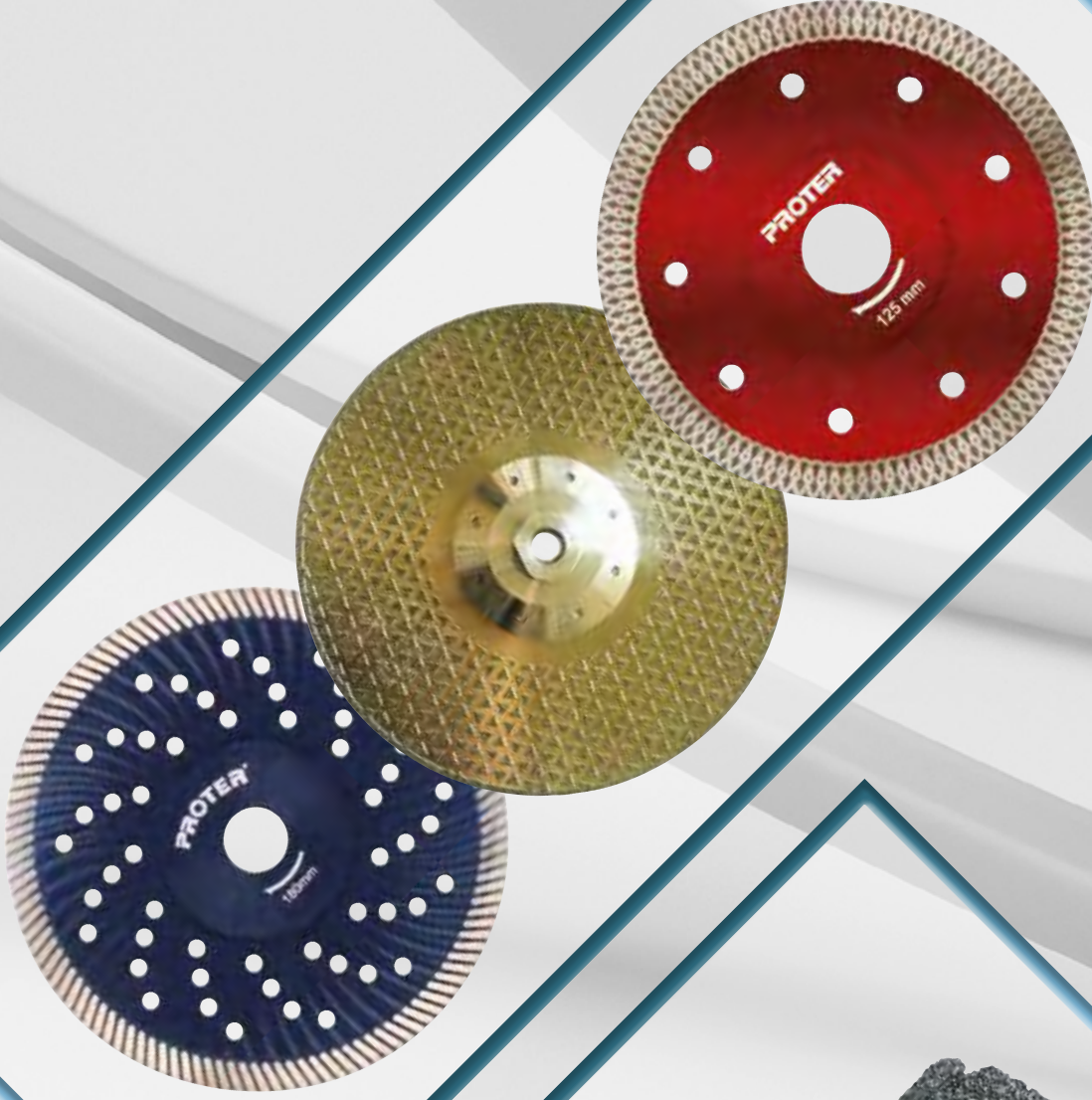

# Üstün Kalite

Ergonomik  
Tasarım

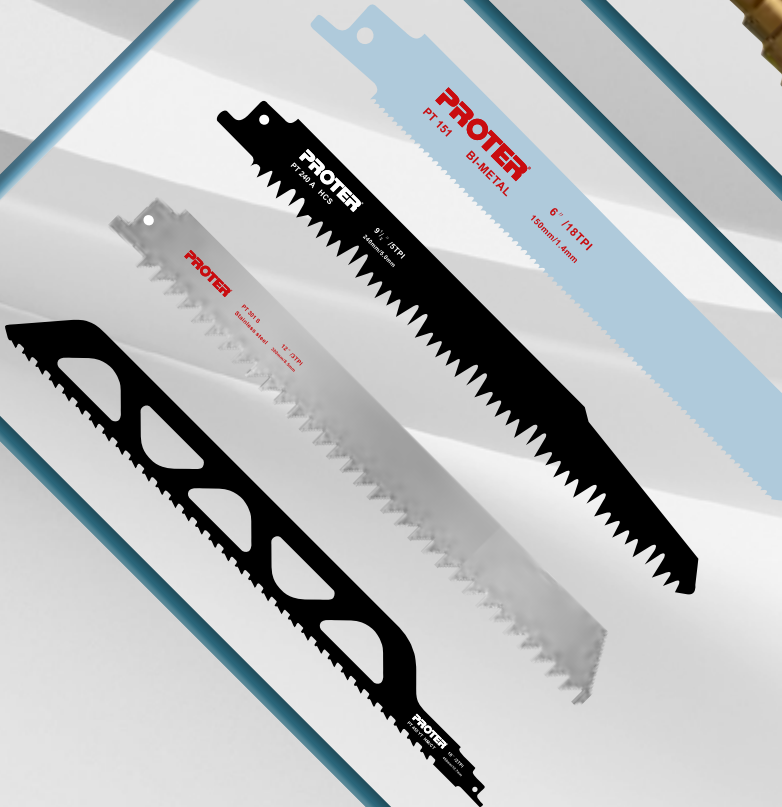
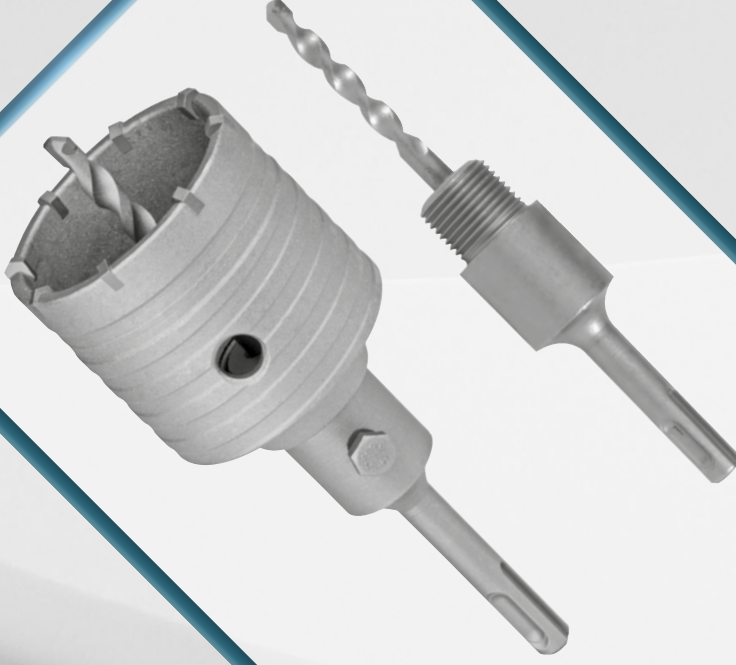

145 \$

## PR 60

### HİDROLİK SU TEST POMPASI

 60 Bar / Çalışma Basıncı

 12 Litre / Tank Kapasiteli



14 \$

## PR 42

### PVC BORU KESME MAKASI

 42 mm

 Otomatik



17 \$

## PR 45

### PVC BORU KESME MAKASI

 45 mm

 Otomatik



## GRANİT-MERMER ELMAS TESTERELER

### SÜPER İNCE HASSAS KESİM ELMAS TESTERELER

Ürün Adı	Kod	Disk Çapı	Göbek Çapı	Birim Fiyat
Süper İnce Kesim	PR 115 CG	<b>115 mm</b>	22.23 mm	<b>8.00 \$</b>
Süper İnce Kesim	PR 125 CG	<b>125 mm</b>	22.23 mm	<b>11.00 \$</b>
Süper İnce Kesim	PR 180 CG	<b>180 mm</b>	22.23 mm	<b>22.00 \$</b>

■ **Kullanım Alanları** • Cam, Granit, Seramik, Porselen

### ÇİFT YÜZEYLİ KESME VE SİLME ELMAS TESTERELER

Ürün Adı	Kod	Disk Çapı	Göbek Çapı	Birim Fiyat
Kesme ve Silme	PR 115 GD	<b>115 mm</b>	Flanşlı-M14	<b>24.00 \$</b>
Kesme ve Silme	PR 180 GD	<b>180 mm</b>	Flanşlı-M14	<b>40.00 \$</b>
Kesme ve Silme	PR 230 GD	<b>230 mm</b>	Flanşlı-M14	<b>60.00 \$</b>

■ **Kullanım Alanları** • Mermer, Granit, Seramik, Doğal Taş

### SÜPER KESİM ELMAS TESTERELER

Ürün Adı	Kod	Disk Çapı	Göbek Çapı	Birim Fiyat
Süper Kesim	PR 180 GM	<b>180 mm</b>	22.23 mm	<b>25.00 \$</b>
Süper Kesim	PR 230 GM	<b>230 mm</b>	22.23 mm	<b>40.00 \$</b>

■ **Kullanım Alanları** • Granit • Mermer • Seramik • Porselen

## ELMAS BETON TESTERELER

### SOKETLİ ELMAS BETON TESTERELER

Kod	Disk Çapı	Göbek Çapı	Birim Fiyat
PR 115 S	<b>115 mm</b>	115 x 1.9 x 7.0 x 22.23	<b>3.40 \$</b>
PR 125 S	<b>125 mm</b>	125 x 2.0 x 7.0 x 22.23	<b>4.20 \$</b>
PR 180 S	<b>180 mm</b>	180 x 2.2 x 7.0 x 22.23	<b>8.00 \$</b>
PR 230 S	<b>230 mm</b>	230 x 2.4 x 7.0 x 22.23	<b>13.00 \$</b>

■ **Kullanım Alanları** • Beton, Taş, Duvar, Tuğla, Fayans, Seramik, Mermer

### TURBO ELMAS BETON TESTERELER

Kod	Disk Çapı	Göbek Çapı	Birim Fiyat
PR 115 T	<b>115 mm</b>	115 x 1.9 x 7.0 x 22.23	<b>3.60 \$</b>
PR 180 T	<b>180 mm</b>	180 x 2.2 x 7.0 x 22.23	<b>8.40 \$</b>
PR 230 T	<b>230 mm</b>	230 x 2.4 x 7.0 x 22.23	<b>13.70 \$</b>

■ **Kullanım Alanları** • Granit, Mermer, Beton, Sert Taş, Kremit, Çini



Hassas Kesim Professional



Çift YüzeYLİ Flanşlı



Süper Kesim Professional



Soketli



Turbo

## TİLKİ KUYRUĞU TESTERE UÇLARI

**PT 155 METAL KESİCİ TESTERE**

150 mm Normal Diş 2.10 \$



**PT 325 P KALIN METAL KESİCİ**

225 mm Ağır Hizmet 3.70 \$



**PT 240 A AĞAÇ KESİCİ TESTERE**

240 mm Hızlı Kesim 2.40 \$



**YTONG & BRİKET KESİCİ TESTERE**

PT 305 YT 305 mm Hızlı Kesim 19.00 \$



**PT 225 METAL KESİCİ TESTERE**

225 mm İnce Diş 3.00 \$



**PT 201 X AHŞAP PALET TESTERESİ**

200 mm Çivi Kesen 3.30 \$



**PT 301 S ET & KEMİK KESİCİ**

300 mm Paslanmaz 2.70 \$



**YTONG & BRİKET KESİCİ TESTERE**

PT 455 YT 455 mm Hızlı Kesim 25.00 \$



**T.C.T. PASLANMAZ METAL DELİCİ PANÇLAR**

UZUN BOY / EXTRA QUALITY	Delme Çapı	Kutu Adet	Birim Fiyat
Elmaslı Paslanmaz Krom Çelik Delme Panç	<b>16 mm</b>	10 Ad.	<b>3.70 \$</b>
Elmaslı Paslanmaz Krom Çelik Delme Panç	<b>19 mm</b>	10 Ad.	<b>4.20 \$</b>
Elmaslı Paslanmaz Krom Çelik Delme Panç	<b>20 mm</b>	10 Ad.	<b>4.70 \$</b>
Elmaslı Paslanmaz Krom Çelik Delme Panç	<b>22 mm</b>	10 Ad.	<b>5.20 \$</b>
Elmaslı Paslanmaz Krom Çelik Delme Panç	<b>25 mm</b>	10 Ad.	<b>5.80 \$</b>
Elmaslı Paslanmaz Krom Çelik Delme Panç	<b>28 mm</b>	10 Ad.	<b>6.50 \$</b>
Elmaslı Paslanmaz Krom Çelik Delme Panç	<b>30 mm</b>	10 Ad.	<b>7.00 \$</b>
Elmaslı Paslanmaz Krom Çelik Delme Panç	<b>32 mm</b>	10 Ad.	<b>7.50 \$</b>
Elmaslı Paslanmaz Krom Çelik Delme Panç	<b>35 mm</b>	10 Ad.	<b>8.00 \$</b>
Elmaslı Paslanmaz Krom Çelik Delme Panç	<b>38 mm</b>	10 Ad.	<b>9.00 \$</b>
Elmaslı Paslanmaz Krom Çelik Delme Panç	<b>40 mm</b>	10 Ad.	<b>9.50 \$</b>
Elmaslı Paslanmaz Krom Çelik Delme Panç	<b>45 mm</b>	6 Ad.	<b>10.50 \$</b>
Elmaslı Paslanmaz Krom Çelik Delme Panç	<b>50 mm</b>	6 Ad.	<b>12.00 \$</b>
Elmaslı Paslanmaz Krom Çelik Delme Panç	<b>55 mm</b>	6 Ad.	<b>13.00 \$</b>
Elmaslı Paslanmaz Krom Çelik Delme Panç	<b>60 mm</b>	6 Ad.	<b>14.00 \$</b>
Elmaslı Paslanmaz Krom Çelik Delme Panç	<b>65 mm</b>	6 Ad.	<b>15.00 \$</b>
Elmaslı Paslanmaz Krom Çelik Delme Panç	<b>70 mm</b>	6 Ad.	<b>16.50 \$</b>
Elmaslı Paslanmaz Krom Çelik Delme Panç	<b>75 mm</b>	6 Ad.	<b>18.00 \$</b>
Elmaslı Paslanmaz Krom Çelik Delme Panç	<b>80 mm</b>	4 Ad.	<b>19.00 \$</b>
Elmaslı Paslanmaz Krom Çelik Delme Panç	<b>85 mm</b>	4 Ad.	<b>20.00 \$</b>
Elmaslı Paslanmaz Krom Çelik Delme Panç	<b>90 mm</b>	4 Ad.	<b>21.50 \$</b>
Elmaslı Paslanmaz Krom Çelik Delme Panç	<b>95 mm</b>	4 Ad.	<b>23.00 \$</b>
Elmaslı Paslanmaz Krom Çelik Delme Panç	<b>100 mm</b>	4 Ad.	<b>25.00 \$</b>
Elmaslı Paslanmaz Krom Çelik Delme Panç	<b>105 mm</b>	1 Ad.	<b>35.00 \$</b>
Elmaslı Paslanmaz Krom Çelik Delme Panç	<b>110 mm</b>	1 Ad.	<b>37.00 \$</b>
Elmaslı Paslanmaz Krom Çelik Delme Panç	<b>120 mm</b>	1 Ad.	<b>40.00 \$</b>



## KADEMELİ SAC DELMELER & ELMASLI BETON DELME PANÇLAR

### 3'LÜ KADEMELİ SAC DELME SETİ

PROFESSIONAL	Özellik	Delme Çapı	Birim Fiyat
<b>3'LÜ KADEMELİ SAC DELME SETİ</b>	Titan Kaplama Ahşap Kutulu	4 - 12 mm	24.00 \$
		4 - 20 mm	
		4 - 32 mm	

### KADEMELİ SAC DELMELER

PROFESSIONAL	Özellik	Delme Çapı	Birim Fiyat
Kademeli Sac Delme	Titan Kaplama	4 - 12 mm	4.50 \$
Kademeli Sac Delme	Titan Kaplama	4 - 20 mm	7.00 \$
Kademeli Sac Delme	Titan Kaplama	4 - 32 mm	11.00 \$
Kademeli Sac Delme	Titan Kaplama	6 - 39 mm	20.00 \$
Kademeli Sac Delme	Titan Kaplama	6 - 52 mm	38.00 \$

### ELMASLI BETON DELME PANÇLAR

Ürün Cinsi	Delme Çapı	Koli Adet	Birim Fiyat
Elmaslı Beton Delme Panç	30 mm	50 Ad.	5.00 \$
Elmaslı Beton Delme Panç	35 mm	50 Ad.	5.50 \$
Elmaslı Beton Delme Panç	40 mm	50 Ad.	6.00 \$
Elmaslı Beton Delme Panç	45 mm	50 Ad.	6.50 \$
Elmaslı Beton Delme Panç	50 mm	50 Ad.	7.00 \$
Elmaslı Beton Delme Panç	55 mm	50 Ad.	7.50 \$
Elmaslı Beton Delme Panç	60 mm	40 Ad.	8.50 \$
Elmaslı Beton Delme Panç	65 mm	40 Ad.	9.00 \$
Elmaslı Beton Delme Panç	70 mm	24 Ad.	10.50 \$
Elmaslı Beton Delme Panç	75 mm	24 Ad.	11.00 \$
Elmaslı Beton Delme Panç	80 mm	24 Ad.	12.00 \$
Elmaslı Beton Delme Panç	90 mm	24 Ad.	16.00 \$
Elmaslı Beton Delme Panç	100 mm	10 Ad.	18.00 \$
Elmaslı Beton Delme Panç	115 mm	10 Ad.	22.00 \$
Elmaslı Beton Delme Panç	120 mm	10 Ad.	24.00 \$
Elmaslı Beton Delme Panç	125 mm	10 Ad.	26.00 \$
Elmaslı Beton Delme Panç	130 mm	10 Ad.	30.00 \$

### BETON DELME PANÇ ADAPTÖRLERİ

		Uzunluk	Birim Fiyat
Yedek Beton Panç Adaptör	Plus	110 mm	3.80 \$
Yedek Beton Panç Adaptör	Plus	250 mm	7.00 \$
Yedek Beton Panç Adaptör	Plus	400 mm	9.00 \$
Yedek Beton Panç Adaptör	Max.	250 mm	7.50 \$



## ELMAS GRANİT & MERMER DELME PANÇLAR (Kuru Delme)



Kuru Delme	Özellik	Delme Çapı	Birim Fiyat
Granit ve Mermer Delme Panç	M14 / Gold	<b>12 mm</b>	10.00 \$
Granit ve Mermer Delme Panç	M14 / Gold	<b>14 mm</b>	11.00 \$
Granit ve Mermer Delme Panç	M14 / Gold	<b>16 mm</b>	12.00 \$
Granit ve Mermer Delme Panç	M14 / Gold	<b>18 mm</b>	12.50 \$
Granit ve Mermer Delme Panç	M14 / Gold	<b>20 mm</b>	13.00 \$
Granit ve Mermer Delme Panç	M14 / Gold	<b>22 mm</b>	14.00 \$
Granit ve Mermer Delme Panç	M14 / Gold	<b>25 mm</b>	15.50 \$
Granit ve Mermer Delme Panç	M14 / Gold	<b>30 mm</b>	17.50 \$
Granit ve Mermer Delme Panç	M14 / Gold	<b>32 mm</b>	19.00 \$
Granit ve Mermer Delme Panç	M14 / Gold	<b>35 mm</b>	21.00 \$
Granit ve Mermer Delme Panç	M14 / Gold	<b>38 mm</b>	22.50 \$
Granit ve Mermer Delme Panç	M14 / Gold	<b>40 mm</b>	23.50 \$
Granit ve Mermer Delme Panç	M14 / Gold	<b>45 mm</b>	26.50 \$
Granit ve Mermer Delme Panç	M14 / Gold	<b>52 mm</b>	31.00 \$
Granit ve Mermer Delme Panç	M14 / Gold	<b>65 mm</b>	38.00 \$

### Plus Adaptör / Pnomatik Matkaplarda kullanım için 4.00 \$

Granit ve Mermer Delme Panç	<b>Adaptörlü</b>	<b>12 mm</b>	10.00 \$
Granit ve Mermer Delme Panç	<b>Adaptörlü</b>	<b>14 mm</b>	11.00 \$
Granit ve Mermer Delme Panç	<b>Adaptörlü</b>	<b>16 mm</b>	12.00 \$

### 3'LÜ KADEMELİ SAC DELME SETİ

Ahşap Kutulu	Delme Çapı	Birim Fiyat
3'lü Set	<b>4-12 mm / 6-20 mm / 6-30 mm</b>	26.00 \$

### KADEMELİ SAC DELMELER

PROFESSIONAL	Delme Çapı	Birim Fiyat
Kademeli Sac Delme	<b>4 - 12 mm</b>	5.00 \$
Kademeli Sac Delme	<b>6 - 20 mm</b>	7.50 \$
Kademeli Sac Delme	<b>6 - 30 mm</b>	13.00 \$
Kademeli Sac Delme	<b>6 - 39 mm</b>	22.00 \$
Kademeli Sac Delme	<b>6 - 52 mm</b>	40.00 \$

## ELMAS DUVAR DELME BUAT UÇLAR / Kuru Delme



Kuru Delme	Uzunluk	Delme Çapı	Birim Fiyat
Elmaslı Duvar Delme Buat uç	170 mm	<b>40 mm</b>	<b>32.00 \$</b>
Elmaslı Duvar Delme Buat uç	170 mm	<b>45 mm</b>	<b>34.00 \$</b>
Elmaslı Duvar Delme Buat uç	170 mm	<b>51 mm</b>	<b>35.00 \$</b>
Elmaslı Duvar Delme Buat uç	170 mm	<b>63 mm</b>	<b>40.00 \$</b>
Elmaslı Duvar Delme Buat uç	170 mm	<b>110 mm</b>	<b>90.00 \$</b>
Elmaslı Duvar Delme Buat uç	170 mm	<b>127 mm</b>	<b>95.00 \$</b>
Elmaslı Duvar Delme Buat uç	170 mm	<b>132 mm</b>	<b>105.00 \$</b>
DUVAR DELME BUAT UÇ ADAPTÖRLERİ		Uzunluk	Birim Fiyat
Yedek Buat uç Adaptör	Plus	<b>160 mm</b>	<b>8.50 \$</b>
Yedek Buat uç Adaptör	Plus	<b>250 mm</b>	<b>10.50 \$</b>
Yedek Buat uç Adaptör	Max.	<b>250 mm</b>	<b>11.50 \$</b>

## BİTS UÇLAR & MANYETİK SOMUN ADAPTÖRLER



### MANYETİK SOMUN ADAPTÖRLERİ

Ürün Cinsi	Ölçü	Koli-Paket-Kutu	Birim Fiyat
Somun Adaptörü	<b>8 x 65 mm</b>	500-50-5	<b>0.70 \$</b>
Somun Adaptörü	<b>10 x 65 mm</b>	500-50-5	<b>0.75 \$</b>
Somun Adaptörü	<b>11 x 65 mm</b>	300-50-5	<b>0.90 \$</b>
Somun Adaptörü	<b>12 x 65 mm</b>	400-50-5	<b>0.95 \$</b>
Somun Adaptörü	<b>13 x 65 mm</b>	400-50-5	<b>1.00 \$</b>
Somun Adaptörü	<b>14 x 65 mm</b>	300-50-5	<b>1.10 \$</b>
Somun Adaptörü	<b>15 x 65 mm</b>	300-30-3	<b>2.00 \$</b>
Somun Adaptörü	<b>17 x 65 mm</b>	300-30-3	<b>2.30 \$</b>



### (Sac Vidaları İçin)



### (Sunta Vidaları İçin)



### YILDIZ BİTS UÇLAR / PH

Ürün Cinsi	Özellik	Ölçü	Koli-Paket-Kutu	Birim Fiyat
Yıldız Bits uç	<b>PH 2</b>	<b>25 mm</b>	2400-1200-60	<b>0.20 \$</b>
Yıldız Bits uç	<b>PH 2</b>	<b>50 mm</b>	1200-600-30	<b>0.40 \$</b>
Yıldız Bits uç	<b>PH 2</b>	<b>75 mm</b>	800-400-20	<b>0.80 \$</b>
Yıldız Bits uç	<b>PH 2</b>	<b>100 mm</b>	500-100-10	<b>1.00 \$</b>
Yıldız Bits uç	<b>PH 2</b>	<b>150 mm</b>	500-100-10	<b>2.00 \$</b>

### YILDIZ BİTS UÇLAR / PZ

Ürün Cinsi	Özellik	Ölçü	Koli-Paket-Kutu	Birim Fiyat
Yıldız Bits uç	<b>PZ 2</b>	<b>25 mm</b>	2400-1200-60	<b>0.20 \$</b>
Yıldız Bits uç	<b>PZ 2</b>	<b>50 mm</b>	1200-600-30	<b>0.40 \$</b>

### S-PLUS BİTS UÇ UZATMA ADAPTÖRÜ

(Pnomatik Matkaplar İçin)	<b>1.20 \$</b>
---------------------------	----------------

## ANAHTARLI & SUPRA MANDRENLER

### ANAHTARLI MANDRENLER

Ölçü	Koli Adet	Birim Fiyat
10 mm 1/2 x 20 UNF	100 Ad.	3.50 \$
10 mm 3/8 x 24 UNF	100 Ad.	3.50 \$
13 mm 1/2 x 20 UNF	50 Ad.	4.50 \$
13 mm 3/8 x 24 UNF	50 Ad.	4.50 \$
16 mm 1/2 x 20 UNF	20 Ad.	9.00 \$

### PLASTİK SUPRA MANDRENLER

Ölçü	Koli Adet	Birim Fiyat
10 mm 1/2 x 20 UNF	100 Ad.	4.00 \$
10 mm 3/8 x 24 UNF	100 Ad.	4.00 \$
13 mm 1/2 x 20 UNF	50 Ad.	5.00 \$
13 mm 3/8 x 24 UNF	50 Ad.	5.00 \$

### METAL SUPRA MANDREN / Kilitli

Ölçü	Koli Adet	Birim Fiyat
13 mm 1/2 x 20 UNF	50 Ad.	9.50 \$

### ANAHTARLI KONİK MANDRENLER

Ölçü	Koli Adet	Birim Fiyat
13 mm B 16 Konik	50 Ad.	4.50 \$
16 mm B 18 Konik	20 Ad.	9.00 \$
20 mm B 22 Konik	10 Ad.	20.00 \$

### SUPRA KONİK MANDRENLER

Ölçü	Koli Adet	Birim Fiyat
13 mm B 16 Konik	25 Ad.	28.00 \$
16 mm B 18 Konik	25 Ad.	35.00 \$



## PLUS ELMAS DELİCİ & KIRICI UÇLAR (Çift Kanallı)

Kod	Ölçü mm	Koli Ad.	Birim Fiyat
Plus Murç	<b>250 mm</b>	100	2.20 \$
Plus Keski	<b>250 mm</b>	100	2.40 \$
Plus Keski	<b>Geniş</b>	100	3.30 \$
Plus Adaptör	<b>1/2</b>	400	0.90 \$

Kod	Ölçü mm	Koli Ad.	Birim Fiyat
Plus uç	<b>5 x 110</b>	400	1.10 \$
Plus uç	<b>5 x 160</b>	400	1.20 \$
Plus uç	<b>5 x 210</b>	300	1.40 \$
Plus uç	<b>5.5 x 160</b>	400	1.25 \$
Plus uç	<b>5.5 x 210</b>	300	1.45 \$
Plus uç	<b>6 x 110</b>	400	1.15 \$
Plus uç	<b>6 x 160</b>	400	1.25 \$
Plus uç	<b>6 x 210</b>	300	1.50 \$
Plus uç	<b>6 x 260</b>	300	1.70 \$
Plus uç	<b>6 x 350</b>	100	2.50 \$
Plus uç	<b>7 x 110</b>	400	1.15 \$
Plus uç	<b>7 x 160</b>	400	1.30 \$
Plus uç	<b>7 x 210</b>	300	1.50 \$
Plus uç	<b>7 x 260</b>	300	1.90 \$
Plus uç	<b>8 x 110</b>	400	1.20 \$
Plus uç	<b>8 x 160</b>	400	1.30 \$
Plus uç	<b>8 x 210</b>	300	1.50 \$
Plus uç	<b>8 x 260</b>	300	2.00 \$
Plus uç	<b>8 x 350</b>	100	2.50 \$
Plus uç	<b>8 x 450</b>	100	3.00 \$
Plus uç	<b>9 x 110</b>	400	1.20 \$
Plus uç	<b>9 x 160</b>	300	1.40 \$
Plus uç	<b>9 x 210</b>	300	1.70 \$
Plus uç	<b>10 x 110</b>	400	1.30 \$
Plus uç	<b>10 x 160</b>	400	1.40 \$
Plus uç	<b>10 x 210</b>	300	1.80 \$
Plus uç	<b>10 x 260</b>	200	2.10 \$
Plus uç	<b>10 x 350</b>	100	2.80 \$
Plus uç	<b>10 x 450</b>	100	3.70 \$
Plus uç	<b>11 x 160</b>	400	1.40 \$
Plus uç	<b>11 x 210</b>	250	1.80 \$
Plus uç	<b>11 x 260</b>	200	2.20 \$



Kod	Ölçü mm	Koli Ad.	Birim Fiyat
Plus uç	<b>12 x 160</b>	250	1.50 \$
Plus uç	<b>12 x 210</b>	250	1.90 \$
Plus uç	<b>12 x 260</b>	200	2.20 \$
Plus uç	<b>12 x 350</b>	100	2.80 \$
Plus uç	<b>12 x 450</b>	100	3.90 \$
Plus uç	<b>13 x 160</b>	250	2.30 \$
Plus uç	<b>13 x 210</b>	200	2.50 \$
Plus uç	<b>13 x 260</b>	200	2.80 \$
Plus uç	<b>14 x 160</b>	250	2.30 \$
Plus uç	<b>14 x 210</b>	200	2.60 \$
Plus uç	<b>14 x 260</b>	150	3.00 \$
Plus uç	<b>14 x 350</b>	100	3.60 \$
Plus uç	<b>14 x 450</b>	50	4.70 \$
Plus uç	<b>15 x 160</b>	250	2.50 \$
Plus uç	<b>15 x 210</b>	200	2.80 \$
Plus uç	<b>16 x 160</b>	250	2.60 \$
Plus uç	<b>16 x 210</b>	200	3.00 \$
Plus uç	<b>16 x 260</b>	120	3.60 \$
Plus uç	<b>16 x 350</b>	100	4.50 \$
Plus uç	<b>16 x 450</b>	50	5.70 \$
Plus uç	<b>18 x 210</b>	100	4.10 \$
Plus uç	<b>18 x 260</b>	100	4.70 \$
Plus uç	<b>18 x 350</b>	50	5.30 \$
Plus uç	<b>18 x 450</b>	50	6.90 \$
Plus uç	<b>20 x 260</b>	100	5.70 \$
Plus uç	<b>20 x 350</b>	50	6.70 \$
Plus uç	<b>20 x 450</b>	25	7.90 \$
Plus uç	<b>22 x 260</b>	100	6.80 \$
Plus uç	<b>22 x 350</b>	50	7.90 \$
Plus uç	<b>22 x 450</b>	25	9.80 \$
Plus uç	<b>24 x 350</b>	40	9.90 \$
Plus uç	<b>24 x 450</b>	25	10.70 \$

## MAX KIRICI MURÇLAR & KESKİLER

Kod	Ölçü mm	Koli Ad.	Birim Fiyat
Max Murç	<b>400 mm</b>	25	5.60 \$
Max Keski	<b>400 mm</b>	25	5.60 \$
Max Keski	<b>(Geniş)</b>	20	7.00 \$
Max Murç	<b>500 mm</b>	25	8.70 \$
Max Keski	<b>500 mm</b>	25	8.70 \$
Max Murç	<b>600 mm</b>	25	9.70 \$
Max Keski	<b>600 mm</b>	25	9.70 \$
Altigen Hex Murç	<b>30x410 mm</b>	15	14.50 \$
Altigen Hex Keski	<b>30x410 mm</b>	15	16.00 \$



## MAX ELMAS DELİCİ MATKAP UÇLARI ( 4 Elmaslı )



Kod	Ölçü mm	Koli Ad.	Birim Fiyat
Max uç	<b>14 x 340</b>	50	9.00 \$
Max uç	<b>14 x 540</b>	40	14.00 \$
Max uç	<b>16 x 340</b>	50	10.00 \$
Max uç	<b>16 x 540</b>	40	14.00 \$
Max uç	<b>18 x 340</b>	40	10.00 \$
Max uç	<b>18 x 540</b>	30	15.00 \$
Max uç	<b>20 x 320</b>	50	10.00 \$
Max uç	<b>20 x 520</b>	25	13.00 \$
Max uç	<b>22 x 320</b>	40	11.00 \$
Max uç	<b>22 x 520</b>	25	14.50 \$
Max uç	<b>24 x 320</b>	30	15.00 \$
Max uç	<b>24 x 520</b>	25	17.00 \$

Kod	Ölçü mm	Koli Ad.	Birim Fiyat
Max uç	<b>25 x 370</b>	25	16.00 \$
Max uç	<b>25 x 520</b>	20	20.00 \$
Max uç	<b>26 x 370</b>	25	16.50 \$
Max uç	<b>26 x 520</b>	20	22.50 \$
Max uç	<b>28 x 320</b>	20	20.00 \$
Max uç	<b>28 x 570</b>	20	28.00 \$
Max uç	<b>30 x 370</b>	20	23.50 \$
Max uç	<b>30 x 570</b>	15	30.00 \$
Max uç	<b>32 x 370</b>	15	23.50 \$
Max uç	<b>32 x 570</b>	15	34.50 \$
Max uç	<b>36 x 570</b>	10	58.00 \$
Max uç	<b>40 x 570</b>	10	71.00 \$

Yüksek Performans  
**Ekonomik**  
Hızlı Servis



# Üstün Kalite

Ergonomik

Tasarım



135 \$

## PH 2522

### HAVALI SOMUN SÖKME 1/2" İKİZ ÇEKİÇ

Soket Çapı	1/2"
Civata Ölçüsü	13 mm
Max. Tork Gücü	520 N.m
Boşta Devir Hızı	8.500 d/dk
Hava Giriş Rekoru	1/4" inch
Hava Hortumu Çapı	10 mm
Çalışma Hava Basıncı	6.3-8 atü
Hava Tüketimi	113 lt/min
Uzunluk Boy	145 mm
Net Ağırlık	1.60 Kg



- 1/2" inch
- 520 N.m Tork
- İkiz Çekiç
- Professional

#### Kullanım Alanları

Orta çaplı otomotiv tamiratlarında, motor bakım ve onarımında montaj sanayinde ve benzeri iş ve alanlarında kullanılan sınıfının 1/2" Professional ürünüdür.

145 \$

## PH 2542

### HAVALI SOMUN SÖKME 1/2" İKİZ ÇEKİÇ

Soket Çapı	1/2"
Civata Ölçüsü	19 mm
Max. Tork Gücü	860 N.m
Boşta Devir Hızı	7.000 d/dk
Hava Giriş Rekoru	1/4" inch
Hava Hortumu Çapı	10 mm
Çalışma Hava Basıncı	6.3-8 atü
Hava Tüketimi	113 lt/min
Uzunluk Boy	185 mm
Net Ağırlık	2.90 Kg



- 1/2" inch
- 860 N.m Tork
- Twin Hammer
- Ağır Hizmet

#### Kullanım Alanları

Ağır çaplı kamyon ve otomotiv tamiratlarında, motor bakım ve onarımında montaj sanayinde ve benzeri iş ve alanlarında kullanılan sınıfının 1/2" Ağır hizmet ürünüdür.

195 \$

## PH 2552 C

### HAVALI SOMUN SÖKME 1/2" İKİZ ÇEKİÇ

Soket Çapı	1/2"
Civata Ölçüsü	19 mm
Max. Tork Gücü	1492 N.m
Boşta Devir Hızı	8.800 d/dk
Hava Giriş Rekoru	1/4" inch
Hava Hortumu Çapı	10 mm
Çalışma Hava Basıncı	6.3-8 atü
Hava Tüketimi	226 lt/min
Uzunluk Boy	193 mm
Net Ağırlık	2.70 Kg



- 1/2" inch
- 1492 N.m Tork
- Twin Hammer
- Ağır Hizmet

#### Kullanım Alanları

Ağır çaplı kamyon ve otomotiv tamiratlarında, motor bakım ve onarımında montaj sanayinde ve benzeri iş ve alanlarında kullanılan sınıfının 1/2" Ağır hizmet ürünüdür.

**P** 150 mm

**P** Vakumlu



**85 \$**

## PH 1350

### HAVALI ORBİTAL DÖNER ZIMPARA

Taban Çapı	150/125mm
Devir / dk	10.000
Orbit Delik Çapı	5 mm
Hava Giriş Rekoru	1/4" inch
Hava Hortumu Çapı	10 mm
Çalışma Hava Basıncı	6.3-8 atü
Hava Tüketimi	226 lt/min
Net Ağırlık	1.0 Kg



#### Kullanım Alanları

Mobilya ve marangoz sektörü ile otomotiv ve boyacılıkta her türlü yüzeylerin zımparalanmasında, düzeltme işlerinde ve benzer alanlarda kullanım için Professional üründür.

**P** 1/2" inch

**P** 680 N.m Tork

**P** Twin Hammer

**P** Professional



**110 \$**

## PH 2532

### HAVALI SOMUN SÖKME

Soket Çapı	1/2"
Civata Ölçüsü	16 mm
Max. Tork Gücü	680 N.m
Boşta Devir Hızı	7.000 d/dk
Hava Giriş Rekoru	1/4" inch
Hava Hortumu Çapı	10 mm
Çalışma Hava Basıncı	6.3-8 atü
Hava Tüketimi	113 lt/min
Uzunluk Boy	193 mm
Net Ağırlık	2.60 Kg



#### Kullanım Alanları

Hafif çaplı kamyon ve otomotiv tamiratlarında, motor bakım ve onarımında montaj sanayinde ve benzeri iş ve alanlarında kullanılan sınıfının 1/2" Profesyonel ürünüdür.

**P** 1/2" inch

**P** Twin Hammer

**P** Professional

**P** 11 Parça Kit



**135 \$**

## PH 2532 K

### HAVALI SOMUN SÖKME 1/2" (11 Parça Çantalı Kit)

Soket Çapı	1/2"
Civata Ölçüsü	16 mm
Max. Tork Gücü	680 N.m
Boşta Devir Hızı	7.000 d/dk
Hava Giriş Rekoru	1/4" inch
Hava Hortumu Çapı	10 mm
Çalışma Hava Basıncı	6.3-8 atü
Hava Tüketimi	113 lt/min
Uzunluk Boy	193 mm
Net Ağırlık	2.60 Kg



#### Kullanım Alanları

Hafif çaplı kamyon ve otomotiv tamiratlarında, motor bakım ve onarımında montaj sanayinde ve benzeri iş ve alanlarında kullanılan sınıfının 1/2" Profesyonel ürünüdür.

270 \$

## PH 2554

### HAVALI SOMUN SÖKME 3/4" İKİZ ÇEKİÇ

Soket Çapı	3/4"
Civata Ölçüsü	28 mm
Max. Tork Gücü	1220 N.m
Boşta Devir Hızı	4.500 d/dk
Hava Giriş Rekoru	3/8" inch
Hava Hortumu Çapı	13 mm
Çalışma Hava Basıncı	6.3-8 atü
Hava Tüketimi	226 lt/min
Uzunluk Boy	247 mm
Net Ağırlık	4.82 Kg



- 3/4" inch
- 1220 N.m Tork
- İkiz Çekiç
- Ağır Hizmet

#### Kullanım Alanları

Ağır çaplı kamyon ve otomotiv tamiratlarında, motor bakım ve onarımında montaj sanayinde ve benzeri iş ve alanlarında kullanılan sınıfının 3/4" Ağır hizmet ürünüdür.

290 \$

## PH 2561

### HAVALI SOMUN SÖKME 1" İKİZ ÇEKİÇ

Soket Çapı	1"
Civata Ölçüsü	38 mm
Max. Tork Gücü	1898 N.m
Boşta Devir Hızı	4.500 d/dk
Hava Giriş Rekoru	3/4" inch
Hava Hortumu Çapı	13 mm
Çalışma Hava Basıncı	6.3-8 atü
Hava Tüketimi	340 lt/min
Uzunluk Boy	243 mm
Net Ağırlık	7.0 Kg



- 1" inch
- 1898 N.m Tork
- İkiz Çekiç
- Ağır Hizmet

#### Kullanım Alanları

Ağır çaplı kamyon ve otomotiv tamiratlarında, motor bakım ve onarımında montaj sanayinde ve benzeri iş ve alanlarında kullanılan sınıfının 1" Ağır hizmet ürünüdür.

335 \$

## PH 2581

### HAVALI SOMUN SÖKME 1" PINLESS

Soket Çapı	1"
Civata Ölçüsü	38 mm
Max. Tork Gücü	2300 N.m
Boşta Devir Hızı	4.000 d/dk
Hava Giriş Rekoru	1/2" inch
Hava Hortumu Çapı	3/4" inch
Çalışma Hava Basıncı	6.3-8 atü
Hava Tüketimi	650 lt/min
Uzunluk Boy	565 mm
Net Ağırlık	13.50 Kg



- 1" inch
- 2300 N.m Tork
- Pinless
- Ağır Hizmet

#### Kullanım Alanları

Ağır çaplı kamyon ve otomotiv tamiratlarında, motor bakım ve onarımında montaj sanayinde ve benzeri iş ve alanlarında kullanılan sınıfının 1" Ağır hizmet ürünüdür.

60 \$

- P** 1800 Devir
- P** Sağ-Sol
- P** Professional



## PH 2440 FR

### HAVALI 10 mm SAĞ - SOL MATKAP

Mandren Kapasitesi	10 mm
Devir Hızı d/dk	1.800
Hava Giriş Rekoru	1/4" inch
Hava Hortumu Çapı	10 mm
Çalışma Hava Basıncı	6.3-8 atü
Hava Tüketimi	170 lt/min
Uzunluk Boy	200 mm
Net Ağırlık	1.2 Kg



#### Kullanım Alanları

Ahşap, alüminyum, demir, bakır ve benzeri ürünleri delmek için genel amaçlı kullanılan (Sağ + Sol) Professional üründür.

50 \$

- P** Çantalı Kit
- P** 9 Parça
- P** Hex uçlar
- P** Professional



## PH 2145 K

### HAVALI KIRICI KESKİ (9 Parça Çantalı Kit)

Keski Boyu	190 mm
Piston Stroke	66 mm
Devir Hızı	3.000 d/dk
Uç Tipi	Round
Hava Giriş Rekoru	1/4" inch
Hava Hortum Çapı	10 mm
Çalışma Hava Basıncı	6.3-8 atü
Hava Tüketimi	140 lt/min
Uzunluk	171 mm
Net Ağırlık	1.44 Kg



#### Kullanım Alanları

İnşaatlarda kırma, kesileme, kazıma ve kanal açma işlerinde, gemicilikte pas, boya gibi doğal ve kimyasal tabakaların kazıma işlemlerinde ve benzeri işler için kullanılan professional hizmet üründür.

115 \$

- P** Çantalı Kit
- P** 4.8 mm
- P** 3/16"
- P** Professional



## PH 2814 K

### HAVALI POP PERÇİN TABANCASI / KİT

Perçinleme Çapı (mm)	4.8 mm
Perçinleme Çapı (inch)	3/16"
Çekim Gücü / mm	720 Kg
Stroke Uzunluğu	14 mm
Hava Giriş Rekoru	1/4"
Hava Hortumu Çapı	10 mm
Çalışma Hava Basıncı	6.3 atü
Yükseklik Uzunluk	283 mm
Net Ağırlık	1.7 Kg



#### Kullanım Alanları

Tüm genel perçinleme işlerini seri ve kolay bir şekilde yapmanıza imkan sağlayan ergonomik bir üründür.

35 \$

## PH 2970 GT

### HAVALI GRES POMPASI 500 CC

Depo Kapasite	500 cc
Hava Giriş Rekoru	1/4" inch
Hava Hortumu Çapı	10 mm
Çalışma Hava Basıncı	30-120 psi
Net Ağırlık	1.32 Kg



Ağır Hizmet

500 cc

Esnek Hortum

#### Kullanım Alanları

Otomotiv ve makina sektöründe gresleme işlerinde kullanılır. Kauçuklu ve ince gres yağı kullanılması gerekir.

60 \$

## PH 2210

### HAVALI CIRCIR KOL

Soket Çapı	1/2"
Tork Gücü / N.m	68 N.m
Cıvata Çapı	13 mm
Devir Hızı	160 rpm
Hava Giriş Rekoru	1/4" inch
Hava Hortumu Çapı	10 mm
Çalışma Hava Basıncı	6.3 atü
Hava Tüketimi	113 lt/min
Uzunluk Boy	265 mm
Net Ağırlık	1.20 Kg



1/2"

Professional

#### Kullanım Alanları

Motor tamiratlarında, buji ve devirdaim pompası, radyatör ve benzeri tamirat işleri için kullanılan genel amaçlı (1/2") üründür.

85 \$

## PH 2210 K

### HAVALI CIRCIR KOL 17 PARÇA KİT

Soket Çapı	1/2"
Tork Gücü / N.m	68 N.m
Cıvata Çapı	13 mm
Devir Hızı	160 rpm
Hava Giriş Rekoru	1/4" inch
Hava Hortumu Çapı	10 mm
Çalışma Hava Basıncı	6.3 atü
Hava Tüketimi	113 lt/min
Uzunluk Boy	265 mm
Net Ağırlık	1.20 Kg



17 Parça Kit

1/2"

Professional

#### Kullanım Alanları

Motor tamiratlarında, buji ve devrialem pompası, radyatör ve benzeri tamirat işleri için kullanılan genel amaçlı (1/2") üründür.

40 \$

17 Parça Kit

3 mm

54.000 Devir



## PH 2756 K

### HAVALI MICRO KALIPÇI (17 Parça Çantalı Kit)

Devir Hızı d/dk	54.000
Pens Çapı	3 mm
Hava Giriş Rekoru	1/4" inch
Hava Hortumu Çapı	10 mm
Çalışma Hava Basıncı	6.3-8 atü
Hava Tüketimi	56 lt/min
Uzunluk Boy	150 mm
Net Ağırlık	0.20 Kg



30 \$

6 mm

22.000 d/dk



## PH 2722

### HAVALI KISA KALIPÇI TAŞLAMA

Devir Hızı d/dk	22.000
Pens Çapı	6 mm
Apex Ölçüsü	1/4" inch
Hava Giriş Rekoru	1/4" inch
Hava Hortumu Çapı	10 mm
Çalışma Hava Basıncı	6.3-8 atü
Hava Tüketimi	113 lt/min
Uzunluk Boy	170 mm
Net Ağırlık	0.60 Kg



37 \$

16 Parça Kit

Çantalı Kit



## PH 2722 K

### HAVALI KISA KALIPÇI TAŞLAMA (Kit)

Devir Hızı d/dk	22.000
Pens Çapı	6 mm
Apex Ölçüsü	1/4" inch
Hava Giriş Rekoru	1/4" inch
Hava Hortumu Çapı	10 mm
Çalışma Hava Basıncı	6.3-8 atü
Hava Tüketimi	113 lt/min
Uzunluk Boy	170 mm
Net Ağırlık	0.60 Kg



#### Kullanım Alanları

Kuyumculuk ve bakır işleme atölyelerinde ve hassas temizlik işlerinin gerektiği sektörlerde yüzeylerin çapak alma ve benzeri temizleme işlemleri için ideal üründür.

#### Kullanım Alanları

Dökümhanelerde, kalıpcı ve kaynak atölyelerinde, otomotiv ve benzeri sektörlerde montaj öncesi yüzeylerin çapak alma ve benzeri temizleme işlemleri için ideal üründür.

#### Kullanım Alanları

Dökümhanelerde, kalıpcı ve kaynak atölyelerinde, otomotiv ve benzeri sektörlerde montaj öncesi yüzeylerin çapak alma ve benzeri temizleme işlemleri için ideal üründür.